

CIAIAC

Comisión de Investigación
de Accidentes e Incidentes
de Aviación Civil

TECHNICAL REPORT

A-002/2003

Accident of aircraft
FOKKER 50,
registration PH-FZE,
at Melilla Airport
(Spain), on 17
January 2003



MINISTERIO
DE FOMENTO

Technical report

A-002/2003

**Accident of aircraft FOKKER 50,
registration PH-FZE, at Melilla Airport (Spain),
on 17 January 2003**



MINISTERIO
DE FOMENTO

SECRETARÍA GENERAL DE
TRANSPORTES

COMISION DE INVESTIGACIÓN
DE ACCIDENTES E INCIDENTES
DE AVIACION CIVIL

Edita: Centro de Publicaciones
Secretaría General Técnica
Ministerio de Fomento ©

NIPO: 161-03-011-0
Depósito legal: M. 23.129-2003
Imprime: Centro de Publicaciones

Diseño cubierta: Carmen G. Ayala

COMISIÓN DE INVESTIGACIÓN DE ACCIDENTES E INCIDENTES DE AVIACIÓN CIVIL

Tel.: +34 91 597 89 63
Fax: +34 91 463 55 35

E-mail: ciaiac@fomento.es
<http://www.fomento.es/ciaiac>

C/ Fruela, 6
28011 Madrid (España)

Foreword

This report is a technical document that reflects the point of view of the Civil Aviation Accident and Incident Investigation Commission (CIAIAC) regarding the circumstances of the accident and its causes and consequences.

In accordance with the provisions of Law 21/2003 and Annex 13 to the Convention on International Civil Aviation, the investigation has exclusively a technical nature, without having been targeted at the declaration or assignment of blame or liability. The investigation has been carried out without having necessarily used legal evidence procedures and with no other basic aim than preventing future accidents.

Consequently, any use of this report for purposes other than that of preventing future accidents may lead to erroneous conclusions or interpretations.

This report has originally been issued in Spanish language. This English translation is provided for information purposes only.

Table of contents

Abbreviations	vii
Synopsis	ix
1. Factual information	1
1.1. History of the flight	1
1.1.1. Takeoff from Malaga, cruise and approach to Melilla	1
1.1.2. Landing at Melilla Airport	2
1.1.3. Actions taken after the crash of the aircraft	3
1.2. Injuries to persons	4
1.3. Damage to aircraft	4
1.4. Other damage	4
1.5. Personnel information	5
1.5.1. Pilot in command	5
1.5.2. Copilot	5
1.5.3. Flight observer	6
1.6. Aircraft information	7
1.6.1. Airframe	7
1.6.2. Description of the brake system	7
1.6.3. Description of the power plant	9
1.6.4. Normal, abnormal and emergency procedures related to the brake system	17
1.6.5. Previous maintenance on the aircraft	19
1.6.6. Loadsheet of the aircraft	22
1.7. Meteorological information	23
1.8. Aids to navigation	24
1.9. Communications	24
1.10. Aerodrome information	24
1.11. Flight recorders	27
1.11.1. Cockpit voice recorder	27
1.11.2. Flight data recorder	32
1.12. Wreckage and impact information	39
1.12.1. Runway tracks and marks in the terrain	39
1.12.2. Wreckage layout	40
1.12.3. Status of the controls and indicators of the aircraft	42
1.13. Medical and pathological information	42
1.14. Fire	43
1.15. Survival aspects	43
1.15.1. Cabin damage	43
1.15.2. Evacuation of the aircraft	45
1.16. Tests and research	46
1.16.1. Testing of the flight idle solenoids on the field	46
1.16.2. Bench testing of components of the propeller, landing gear and brake systems	47
1.16.3. Estimate of the performances of the aircraft	52
1.17. Organizational and management information	53

1.17.1. Organization of Air Nostrum	53
1.17.2. Organization of Denim Air	53
1.18. Additional information	57
1.18.1. Stabilized approach concept	57
1.18.2. Landing distance requirements	58
1.18.3. Instructions provided by the operator for landings at Melilla	59
1.18.4. Maintenance safety actions carried out by the operator of the aircraft	59
1.18.5. Operational safety actions carried out by the operator of the aircraft	60
1.19. Useful or effective investigation techniques	61
2. Analysis	63
2.1. General	63
2.2. Aircraft systems malfunctions during the landing roll	65
2.2.1. Malfunctions in the braking system	66
2.2.2. Impossibility to select propeller reverse after touchdown	68
2.3. Operational aspects	70
2.3.1. Decision to change the landing runway	70
2.3.2. Final approach and touchdown	71
2.3.3. Braking and propeller reverse application	73
2.3.4. Landing distance	75
2.4. Crashworthiness and survival aspects	76
3. Conclusions	79
3.1. Findings	79
3.2. Causes	80
4. Safety recommendations	81
Appendices	83
Appendix A. Diagram of the horizontal trajectory of the aircraft	85
Appendix B. Ground track of the aircraft and marks on the terrain	89
Appendix C. Photos of the ground track	95
Appendix D. DFDR graphs	101

Abbreviations

00 °C	Degrees Celsius
A	Ampere
ABSC	Aircraft Braking Systems Corporation
AENA	Aeropuertos Españoles y Navegación Aérea, operator of the Airport of Melilla and provider of Air Traffic Control Services
AFM	Aircraft Flight Manual, prepared by the manufacturer
AGL	Above Ground Level
AMM	Aircraft Maintenance Manual
ANS	Air Nostrum
AOM	Aircraft Operating Manual, prepared by the manufacturer
ASI	Airspeed indicator
ATC	Air Traffic Control
ATPL	Airline Transport Pilot
CAP	Central Annunciator Panel
CB	Circuit breaker
CIAIAC	Comisión de Investigación de Accidentes e Incidentes de Aviación Civil
CLB	Climb
CMM	Component Maintenance Manual
CPL	Commercial Pilot
CRM	Crew Resource Management
CRZ	Cruise
CTL	Control
CVR	Cockpit Voice Recorder
DFDR	Digital Flight Data Recorder
DME	Distance Measuring Equipment
DSB	Dutch Safety Board, in charge of air accidents investigation in The Netherlands since 1 February 2005
DTSB	Dutch Transport Safety Board, in charge of air accidents investigation in The Netherlands in the date of the accident
EEC	Electronic Engine Control
EMI	Electromagnetic interference
ERP	Engine Rating Panel
FAR	Federal Aviation Regulations
FCOM	Flight Crew Operating Manual
FLX	Flexible (take off schedule and rating of the engines)
FLT	Flight
ft	Feet
GA	Go-around
GEML	ICAO location indicator of the Airport of Melilla
GRN	Ground
GPWS	Ground Proximity Warning System
h: min: s	Hours, minutes, seconds
HIL	Hold item list
hPa	Hectopascal
IAS	Indicated airspeed
ICAO	International Civil Aviation Organization
in	Inch(es)
IPC	Illustrated Parts Catalog
JAR-OPS	Joint Aviation Requirements-Operations
KIAS	Knots of indicated airspeed
kt	Knots
lb	Pounds
LDA	Landing distance available
LDR	Landing distance required
LEMG	ICAO locator indicator of the Airport of Málaga
LH	Left hand

Abbreviations

LIR	Load inspection report
m	Meter
MAC	Mean aerodynamic chord
mb	Milibar
MEL	Identifier of the VOR of Melilla
METAR	Meteorological report
MHz	Megahertz
MLG	Main landing gear
mm	Milimeter
mph	Miles per hour
MSA	Minimum Safe Altitude
n°	Number
NDB	Non directional beacon
NLG	Nose landing gear
NM	Nautical Mile
OM	Operations Manual, prepared by the operator
P/N	Part Number
PAPI	Precision Approach Path Indicator
PF	Pilot flying
PNF	Pilot not flying
psig	Pounds per square inch gauge
RH	Right hand
rpm	Revolutions per minute
s	Seconds
S/N	Serial Number
SB	Service Bulletin
SBF	Service Bulletin Fokker
SED	Service Experience Digest
SKID CTL	Antiskid control
TO	Takeoff
TSB	Transportation Safety Board of The Netherlands
TWR	ATC Control Tower
UTC	Universal Coordinated Time
VOR	Very high frequency omni directional range
Vref	Landing threshold speed. The speed during final approach at 50 ft height above the runway. The landing speed is not less than 1.3 Vs (stall speed)
Vs	Stall speed at a given configuration

Synopsis

Operator:	Denim Air
Aircraft:	Fokker 50, PH-FZE
Date of the accident:	17-01-2003
Place of the accident:	Airport of Melilla
Persons aboard:	5 crew and 14 passengers
Type of operation:	Commercial air transport. Scheduled domestic passenger
Approval date:	21 December 2005

Summary of the accident

The accident was notified by phone to the CIAIAC on 17 January 2003 at around 12:30 h local. Investigators of the CIAIAC travelled to the place of the accident on the same day, inspected the wreckage and recovered the flight recorders. The Dutch Transport Safety Board (DTSB)¹ was notified and participated in the investigation as State of Registration, of Operation, and of Manufacture of the aircraft. Experts from Fokker Services B.V., Denim Air and Air Nostrum also assisted in the investigation.

On 17 January 2003, the aircraft Fokker 50 registered PH-FZE, with 5 crew and 14 passengers on board, landed on runway 15 of Melilla Airport. During the landing, the pilot in command noticed that he could not engage the ground idle/reverse of both propellers, and that the aircraft did not brake normally. The aircraft started to deviate to the left of the runway axis while both pilots were applying brakes. After tyre number 3 burst, the deviation continued until the aircraft left the paved surface of the runway and finally fell through an embankment with around 15 m of height located at the end of runway 15.

The aircraft was destroyed and the pilot in command and other nine people suffered minor injuries. There was no fire.

The investigation determined that the accident was probably produced by a combination of three factors:

1. An unstable approach that resulted in a higher than normal touchdown speed.
2. The inability to select propeller reverse due to the probable tripping of the circuit breaker «FLIGH IDLE SOLENOID 1 & 2» before or at touchdown.

¹ On 1 February 2005 the name of the Dutch Transport Safety Board was changed into The Dutch Safety Board (DSB).

3. The cross connection of the wheel speed transducer wire harness of wheels 3 and 4, which, due to heavy braking, produced a flat spot in, and subsequent deflation of wheel 3 and reduced the braking capability of wheel 4.

Several safety actions were already taken by the manufacturer and the operator of the aircraft during the investigation, and other were recommended as a result of the conclusions of this report.

1. FACTUAL INFORMATION

1.1. History of the flight

1.1.1. *Takeoff from Malaga, cruise and approach to Melilla*

On 17 January 2003 the flight crew of aircraft Fokker 50, registration PH-FZE, flight number ANS-8276 arrived at the office of the company Air Nostrum at Malaga Airport (LEMG) at around 9:30¹ h UTC time. The flight was being operated by Denim Air, under a wet-lease agreement with Air Nostrum. The flight crew was composed of the pilot in command, the copilot and there was also another company pilot that had recently obtained his type rating in Fokker 50 and who was going to act as an observer from the jump seat in the cockpit. Two flight attendants were also a part of the crew. They boarded aircraft Fokker 50 PH-FZE at around 9:45 h with the intent to carry out a scheduled passenger transportation flight with destination to Melilla Airport (GEML), with an estimated flight duration time of 45 min.

There were 14 passengers boarding the aircraft, which had enough fuel for the round trip to Melilla and back to Malaga, because there were no refuelling facilities at Melilla Airport.

The copilot carried out the pre-flight walk-around inspection of the aircraft in the company of the observer pilot. The pilot in command carried out the cockpit pre-flight checks. He had been provided with the cargo manifest but he found that another 300 kg of last-minute cargo were being loaded in the forward cargo compartment. Due to this fact, he instructed the two cabin attendants to have the passengers seated in the rear part of the cabin, for mass and balance purposes. The passengers were thus instructed to seat rearwards of row n° 7.

At 10:13 h the crew contacted Clearance and had approval for start up.

The aircraft took off at 10:30 h and it was cleared to proceed directly to Melilla at flight level 130. They contacted Melilla Control Tower at 10:48 h, when the aircraft was still at flight level 130. The pilot in command acted as the pilot flying (PF) during the whole flight. The copilot managed the communications and acted as pilot not flying or pilot monitoring (PNF). The third pilot was an observer seated at the jump seat and received general descriptions of the operation and read some checklists.

The tower cleared them to descend at their discretion and informed that runway in use was 33.

¹ All times in this report are UTC except where otherwise stated. It is needed to add 1 h to obtain the local time.

At 10:54:34 h another flight of the same company call sign ANS-8971 that was at 37 NM North of DME as number 2 in the approach, and that has been informed that runway in use was 33, requested a change of runway to 15 and added «if no possible to the traffic it's no problem...», meaning that they preferred runway 15 but did not want to cause problems to ANS-8276 that was preceding them in the approach.

The air traffic controller advised that aircraft PH-FZE was going to runway 33 and that unless they accepted a change in the runway, number 2 would necessarily have to go to runway 33.

The ATC asked the crew of PH-FZE «would you admit to use one five or do you prefer to keep on runway three three?» The question was repeated and it took some time for the crew of PH-FZE to answer: «We can accept runway one five» at 10:56:25 h. They were then cleared to runway 15 with wind 250° and 11 kt.

At those moments aircraft PH-FZE was 12 NM out of the field in radial 330° of VOR MEL and passing through 6,000 ft (see Figure 1 in Appendix A).

At 11:00:13 h the aircraft was cleared to land with wind 240° at 12 kt varying between 210° and 300°.

1.1.2. *Landing at Melilla Airport*

Due to the runway change, the pilot in command had decided to land with flaps 35° and a reference speed of 95 KIAS, and he amended in hand writing the corresponding landing card he was using on board.

The aircraft made some «S-turns» to lose altitude because, according to the statement of the pilot in command, it was a little high in the approach path.

The aircraft continued with the approach and, according to the DFDR data, when it was at 51 ft of radio-height, the airspeed was 115 KIAS. At 36 ft the airspeed was 119 KIAS, and at 28 ft it was 118 KIAS. At those moments, the aircraft had not yet passed over the displaced threshold of runway 15, which was overflowed at approximately 15 ft of height.

At around 11:00:37 h there was a «ground mode» signal recorded in the DFDR for the first time, with a speed between 98 and 101 KIAS. The next sample of this parameter in the DFDR is an «air mode» signal with 101 KIAS. This signal of «air mode» was continuously recorded for 13 additional samples until it changed to «ground» at the moment the aircraft had between 86 and 82 KIAS, at around 11:00:45 h. The signal did not change any more during the rest of the landing roll over the runway.

During the landing, the pilot in command realised that he could not engage the propeller ground idle/reverse, he said «I have no reverse» and applied brakes in an attempt to stop the aircraft. Later on, the co-pilot also applied brakes.

During the landing roll the aircraft did not decelerate as could have been expected in a normal braking situation. The wheel number 3 became locked and was deflated by a flat spot.

The aircraft started to veer to the left of the runway until wheel number 1 left the asphalt zone at around 150 m before the end of the runway. The alternate brakes were never used.

The four wheels of the main landing gear eventually exited the asphalt zone at the end of runway 15, and the aircraft fell through a slope of around 15 m of height that was located at the end of the runway. During the first part of the subsequent trajectory, the aircraft lost contact with the ground, and a new signal of «air mode» was recorded on the DFDR at around 11:00:59 h, when the aircraft had between 49.6 and 48.4 KIAS.

After the two legs of the main landing gear hit the ground, the wing detached from the fuselage. Later on, the wing turned around its longitudinal axis making the propeller spinners to hit the ground and breaking and detaching the twelve blades.

At the end of its movement, the aircraft came to a rest leaning against the perimeter fence of the airport, close to its access road. The fuselage broke by the zone of seat rows 6 to 8, and the floor was heavily deformed between those rows.

1.1.3. *Actions taken after the crash of the aircraft*

The statements gathered suggest that after the aircraft came to a stop, the pilot in command had been injured, and the crew was frozen for a while, until the flight observer pilot stated that the occupants should leave the aircraft immediately and started carrying out the «on ground emergency» checklist. He pulled both fire handles and tried to close both fuel levers, but he was unable to close those levers. Then the captain turned on the evacuation lights.

In the mean time, after a while and in absence of commands from the cockpit, the rear flight attendant instructed the passengers, who were all seated in the rear part of the cabin, to leave the aircraft through door 2R, which opened without problem.

The forward cabin attendant and the three pilots left the aircraft through door 1R, which was difficult to open. Door 1L could not be opened, because the outside lever was trapped by the fence of the airport. Door 2L, which was fully operative, was never intended to be opened.

The airport emergency services arrived when all the occupants had left the aircraft, and the fire fighters applied powder to the engines. There was no fire.

The occupants of the aircraft were initially attended by the medical services of the airport. Some of them were taken to Melilla Hospital, and the pilot in command and a passenger remained hospitalised for observation. They were released from hospital within 48 h.

1.2. Injuries to persons

Injuries	Crew	Passengers	Total in the aircraft	Others
Fatal				
Serious				
Minor	1	9	10	Not applicable
None	4	5	9	Not applicable
TOTAL	5	14	19	

1.3. Damage to aircraft

The aircraft suffered major damage to the upper part of the fuselage, which was broken due to the displacement of the wing that detached from its fittings, moved the ceiling and left a major part of the cabin in the open. The central part of the cabin floor was badly damaged and deformed, causing several seats to detach from the tracks and the overhead bins of that central part of the cabin fell over the seats. Both propellers and the nose landing gear were also highly damaged.

Although the cockpit and the rear part of the fuselage, including the empennages, remained almost undamaged, the destruction of the central part of the fuselage and movement of the wing made the airframe to be considered destroyed and the aircraft was written off.

1.4. Other damage

The perimeter fence of the airport was damaged in a length of approximately 40 m, and a runway edge light was broken by the left MLG leg during the landing roll.

A wiring control box of the anti-intrusion system of the perimeter fence of the airport was also destroyed.

1.5. Personnel information

1.5.1. Pilot in command

Sex, age:	Male, 57
Nationality:	Canadian
License:	— Airline Transport Pilot (Canadian and U.S.A.) — JAA ATPL (A) (issued by The Netherlands)
JAA License issued:	31-03-1999
JAA License valid until:	18-06-2007
Type rating:	DC-6, DC-3, F-27, FH227, B-25; Pilot in command of Fokker 50; Instrument Rating (IR-ME(A)); Type Rating Instructor (TRI(A))
Class I Medical Certificate:	Valid until 06-05-2003
Total flight time:	Approx. 12,900 h
Hours in the type Fokker 50:	Approx. 3,500 h, always as pilot in command
Hours in the last 72 h:	5.4 h
Hours in the last 30 days:	30.4 h
Hours in the last 90 days:	136.5 h

His current duty period had started on 17 January at 9:35 h. He previously had 15:15 h of rest.

The pilot in command had completed a Crew Resource Management (CRM) recurrent training at Denim Air in June 2002.

1.5.2. Copilot

Sex, age:	Male, 31
Nationality:	Dutch
License:	Commercial Pilot JAA-CPL (A) (issued by The Netherlands)
License issued:	30-08-2000
License valid until:	09-07-2003
Type rating:	Instrument Rating (IR-ME(A)); copilot in Fokker 50, since 13-1-2003
Class I Medical Certificate:	Valid until 21-05-2003
Total flight time:	457 h

Hours in the type Fokker 50: 64 h (exclusive 35 type rating training in simulator)
Hours in the last 72 h: 5.4 h
Hours in the last 30 days: 30.4 h
Hours in the last 90 days: 136.5 h

His current duty period had started on 17 January at 9:35 h. He previously had 23:55 h of rest.

The copilot had flown to Melilla (landing on runway 33) three times before; one as flight officer and two as flight observer. On 17 January 2003 he made his first landing on runway 15.

The copilot had completed a Crew Resource Management (CRM) initial training at Denim Air in October 2002. The course subjects included management of workload, tiredness and fatigue, vigilance management of stress, personality type, delegation and effective communications skills.

1.5.3. *Flight observer*

Sex, age: Male, 29
Nationality: Dutch
Title: Commercial Pilot (CPL (A))
Type rating: Copilot in Fokker 50, since 18-12-2002
Class I Medical Certificate: Valid until 21-05-2003
Total flight time: 250 h
Hours in the type Fokker 50: 1 h (plus 35 h in flight simulator)
Hours in the last 72 h: 5.5 h (as an observer from the jump seat on F-50)
Hours in the last 30 days: 5.5 h (as an observer from the jump seat on F-50)
Hours in the last 90 days: 5.5 h (as an observer from the jump seat on F-50)

His current duty period had started on 17 January at 9:35 h. He previously had 23:55 h of rest.

The flight observer had made 6 flights as an observer the two days before the date of the accident, including a landing on runway 33 at Melilla.

The flight observer had completed a Crew Resource Management (CRM) initial training at Denim Air in November 2002.

1.6. Aircraft information

1.6.1. Airframe data

Make:	Fokker Aircraft ²
Model:	F.27 Mk. 050 (Fokker 50)
Serial number:	20182 (effectivity number in the AMM: 008)
Registration:	PH-FZE
MTOW:	20,820 kg
Operator:	Denim Air
Year of manufacture:	1990
Total flight time:	22,534 h
Total flight cycles:	25,803
Certificate of Airworthiness:	Standard. Renewed on 24-12-2002. Valid until 15-10-2003

Aircraft PH-FZE had the following flight idle stop related modifications installed at the manufacturer factory:

- 78220 Introduction of modified spring assy. for flight idle lock solenoid.
- 78292 Automatic flight idle stop. A change to the circuit breaker trip rate
- 79607 Automatic flight idle stop. Enlargement of clearances in the flight idle lock mechanism
- 79070 Introduction of new shaft/lever flight idle lock system

The aircraft was exported from Spain to The Netherlands and changed its registration from EC-HUB to PH-FZE in October 2002.

1.6.2. Description of the brake system

In the description of the Aircraft Operating Manual issued by the manufacturer, it is stated that the hydraulic brake system is mechanically operated by the brake pedals. The brake system is equipped with a skid-control system which modulates the brake pressure. It is also possible to operate the brake system in an alternate mode, which has no skid-control provisions. There are two separate gauges in the cockpit, one for the indication of the normal brake pressure and another to display the alternate brake pressure.

² The original manufacturer was Fokker Aircraft. However, at the time of the accident the Type Certificate holder was another company called Fokker Services. Throughout this report, reference to the «aircraft manufacturer» must be understood as referring to Fokker Aircraft of Fokker Services as applicable.

1.6.2.1. Skid control system

With the skid-control (sometimes called «antiskid») system operating, individual wheel-brake pressure is continuously and rapidly modulated to guarantee that each wheel has the maximum effective braking force (according to a pre-programmed schedule) without locking the wheel. It has a skid control box, wheel speed sensors and skid control valves.

In addition to ground/flight information and electrical power on/off signal, the skid control box receives the deceleration signal of every wheel (there are four wheel speed sensors, one per wheel of the MLG) and, if required, signals the relevant skid control valve to reduce pressure as needed.

If one of the wheels decelerates to a point where it may lock and burst, the relevant brake pressure is fully released to allow the wheel to spin up. This feature is called «locked wheel protection» and it is inactive at normal taxi speed. However, this mode releases all the pressure from the brakes in flight with the landing gear down (to prevent landings with brakes on) and for a period of seven seconds after touchdown in case of no wheel spin-up for any reason, like for example hydroplaning. When the wheel speed is above 30 kt, the skid control is in operation for that wheel.

The wheel speed signals are grouped in two channels: outboard (wheels 1 and 4) and inboard (wheels 2 and 3).

There is a SKID CTL light in the Central Annunciator Panel (CAP) of the cockpit that comes on when there is a skid control failure. The failures are also shown in the skid control box with two magnetic indicators that show black and white in the event of a failure.

1.6.2.2. Alternate brake system

The alternate brake system is operated through two handles located at the left side of the cockpit, instead of through the pedals. Every handle moves an alternate brake-control valve that transmits all the pressure (without any skid control) to the wheels of its side. Therefore, differential braking is possible. In the event of a hydraulic failure, an accumulator allows a limited number of full brake applications.

1.6.2.3. In-service problems of the antiskid system

There were two in-service problems on the F50 type involving the antiskid box and other components of the brake system.

SB F50-32-024 was issued to replace the wires that were routed to the wheel speed sensors inside the main landing gear legs (the wires were found broken in some instances). However, during accomplishment of this SB, sometimes the new wires were installed «cross wired», i.e. the inboard wheel speed sensor gave signal to the outboard channel of the anti-skid control box and the other way around.

To overcome the problem, Fokker issued in June 1994 SB F50-32-030 in which specific instructions were given to check whether the wires were crossed after compliance with SB F50-32-024. Those instructions were also introduced in the AMM, and were in force at the time of the accident in Melilla. The test used the «sensor» and «valve» lights of the skid control unit in the antiskid control box.

Aircraft PH-FZE had neither complied with SB F50-32-024 nor with SB F50-32-030.

The AMM also covers the issue of wire harness cross wiring in the fault isolation section for wheels and brakes (task 32-40-00-811-851-A). Flat spots in one tire or one tire burst could be produced by several causes. One of them, identified after carrying out four steps of the fault isolation chart, is that the «wiring of the wheel speed sensor is installed incorrectly - the outboard wiring to the inboard wheel speed sensor».

In May 2003, some time after the Melilla accident, Service Bulletin SBF50 32-038 was issued by Fokker to modify the Skid Control Unit to provide a solution for reported pulsating brake behaviour and loss of braking at low speeds in the normal braking mode, which was shown to be due to electromagnetic interference (EMI), caused by failed components in other electronic systems and induced on the wheel speed sensor and/or test inputs. This SB Fo50-32-38 was later mandated by the CAA of The Netherlands with Airworthiness Directive 2003-091. This service bulletin requires, among other tasks, the modification to the antiskid control box as included in SB Fo50-32-24.

In April 2004 and AMM change was issued to prevent cross connection of the wheel speed sensor cables.

1.6.3. *Description of the power plant*

The aircraft has two Pratt & Whitney PW 125B turboprop engines attached to the wing with the corresponding nacelles. Each engine drives a Dowty Rotol constant speed propeller with six blades. The propellers are pitch reversible to provide reverse thrust during landing or rejected takeoff.

Both power plants are controlled through an electronic control unit that adjust fuel flow and calculates the target torque of the engine depending on the power lever position and engine rating selected by the pilot, and by a Propeller Electronic Control that commands the propeller speed.

The engine rating is selected in an engine rating panel (ERP) that allows the pilot to choose among TO (take off), GA (go-around), FLX (flexible takeoff), MCT (maximum continuous), CLB (climb) and CRZ (cruise) ratings.

The GA rating can also be selected, in flight only, pushing the go-around buttons on the power levers (see Figure 1.6.3.1). This rating is selected automatically upon touchdown. Approximately 16 seconds after touchdown, provided the aircraft is still on the ground, the TO rating is automatically selected.

1.6.3.1. Propeller control

1.6.3.1.1. *General*

The propeller speed is controlled by the Propeller Electronic Control unit that commands the blade pitch angle. Depending on the engine rating selected, the speed of the propeller is controlled to 100% (for TO, FLX, MCT and GA ratings) or to 85% (for CLB and CRZ ratings).

Propeller pitch in flight varies from approximately $+15^\circ$ (in approach and landing) to $+45^\circ$.

Apart from this range of constant speed of the propeller, the power lever controls directly the pitch angle below the flight idle position (from $+15^\circ$ to -17° , which corresponds to full reverse) which is called the «beta range». This latter range must not be used in flight, because high drag will occur compromising the controllability of the aircraft. The power levers quadrant is marked with gates for takeoff power, flight idle, ground idle, and reverse.

In beta control mode, the minimum speed of the propeller is 80% when go-around rating is selected, or 62.5% with the other ratings selected. In full reverse position, the speed of the propeller is approximately 95%.

The aircraft automatically selects GA rating when the aircraft is on the ground, and the propeller speed is therefore set at 80%. After 16 seconds, the system automatically switches to TO rating, which makes the propeller speed to decay to 62.5%. During the landing roll at GA rating, there could be a point where the pitch of the blades lowers to a point in which the fixed speed of the propeller can no longer be maintained with the current torque of the engine, and the EEC (Electronic Engine Control) automatically increases the fuel flow and hence the ITT, turbine rpm and torque.

Therefore, it is normal to see an automatic increase of those engine parameters during the landing roll.

To move the power levers below the flight idle detent, the pilot must lift by hand a piggyback lever called the «ground range selector» that is also mounted on the power lever (see Figures 1.6.3.1 and 1.6.3.2).

To prevent inadvertent in-flight selection of power settings below flight idle, there is a mechanical stop that moves out and in when a solenoid is energized or de-energized,

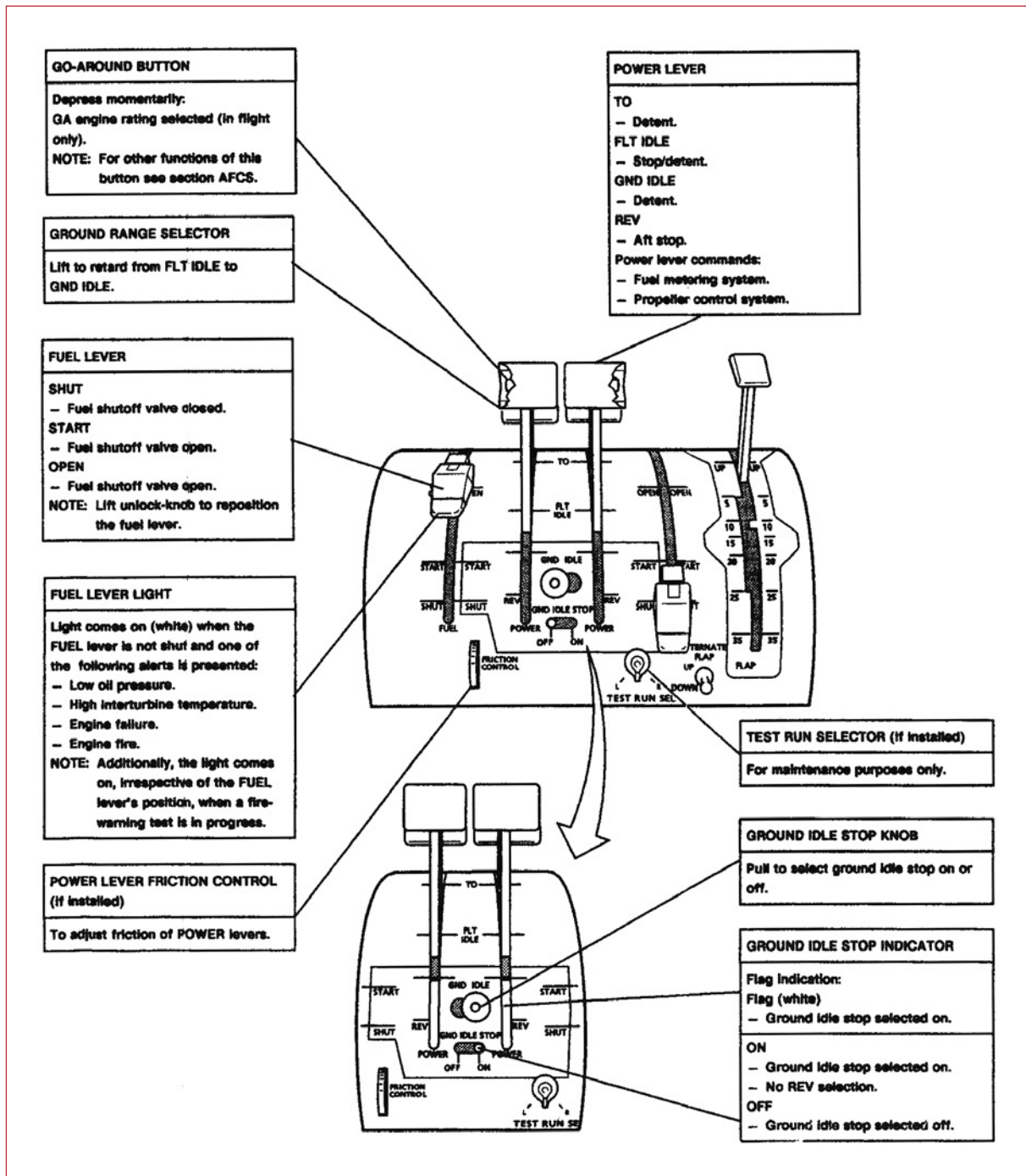

Figure 1.6.3.1. Power lever quadrant (from the Aircraft Operating Manual prepared by Fokker)

respectively. Unless certain conditions are met (see next paragraph), the corresponding power lever cannot be moved below the flight idle position, even if the pilot raises the «ground range selector». Except in the event of a failure, this is only possible when the aircraft is on the ground and therefore the solenoid is energized and retracts the automatic flight idle stop.

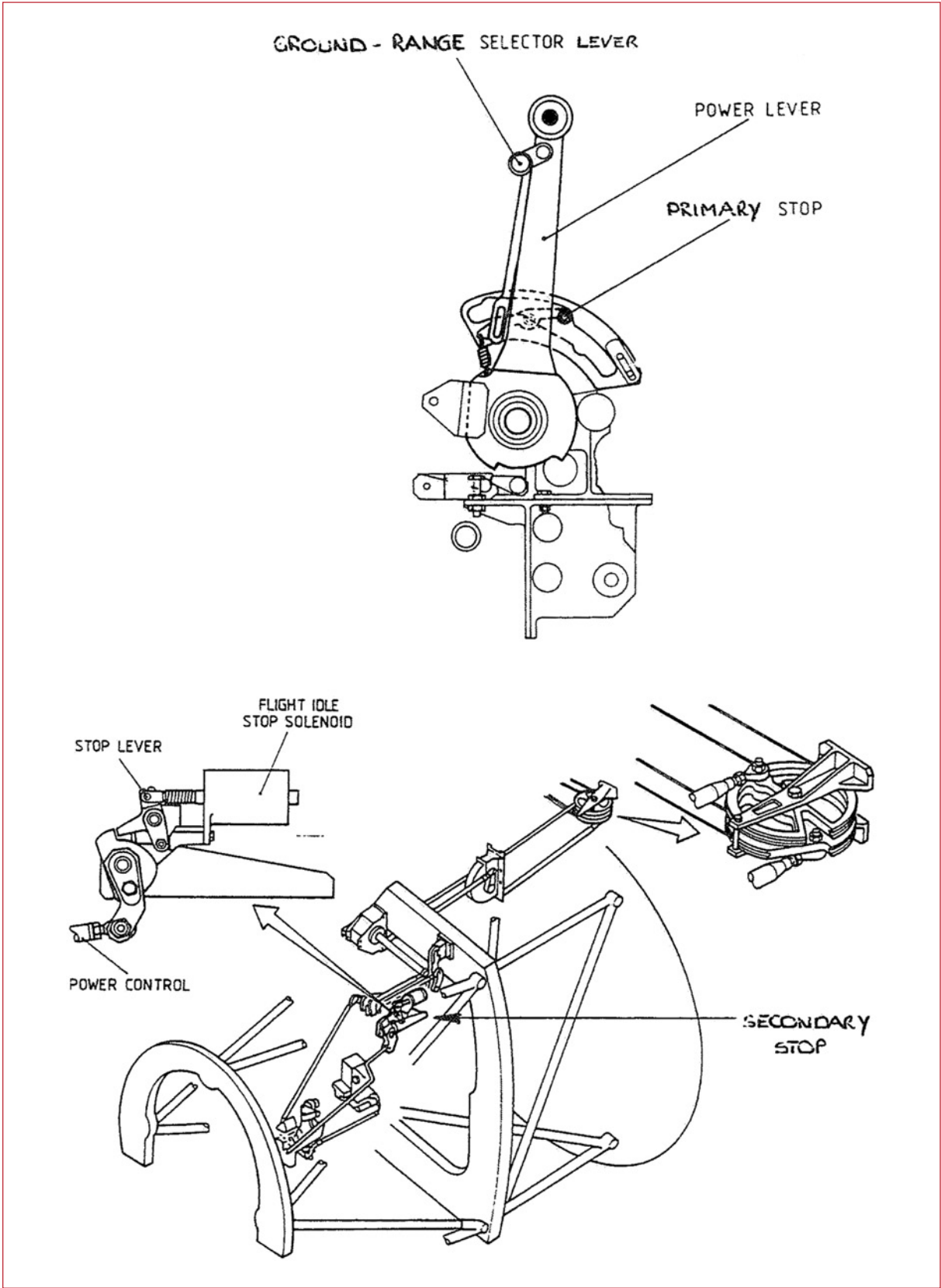

Figure 1.6.3.2. Detail of the automatic flight idle stop assembly (from Fokker SL 137)

However, the contrary is also true: if certain failures happen, and the solenoid is not energized on the ground, the automatic flight idle stop is not removed and ground idle or thrust reverse cannot be selected when desired by the pilot. There is no «override» feature on the cockpit to overcome this possible fault.

There is also another purely mechanical stop that is used only during takeoff to prevent propeller reverse selection in the event of a rejected take off. This stop is engaged by the crew by moving to «on» a knob located in the power levers pedestal (see Figure 1.6.3.1). In the «Before takeoff» checklist carried out by the crew, this knob is checked to be on. Later on, in the «Before approach» checklist, the knob is checked to be off to be sure that reverse will be available during the landing roll. The reason for this knob is that, due to the large propeller pitch changes needed from takeoff to full reverse, it was found that the accelerate-stop distance is actually shorter when reverse is not selected in a rejected takeoff.

In summary, there are three different means to prevent inadvertently moving the power levers in reverse:

Name (in this report)	Description	May it be overridden in flight from the cockpit?
Ground range selector, primary or mechanical flight idle stop	After touchdown, the pilot lifts a piggyback lever mounted on each power lever	Yes (release the lever)
Ground idle stop knob	The pilot moves a knob located between the power levers to ON (during pre-takeoff checklist) or OFF (during the approach checklist)	Yes (move the knob to off)
Automatic flight idle stop (sometimes called «secondary stop»)	A solenoid is automatically energized/de-energized to remove/apply a stop that prevents movement of the power lever below flight idle. It is activated by the ground-air logic or by wheel spin-up after touchdown	No

1.6.3.1.2. *Automatic flight idle stop solenoid*

According to the information provided by the Aircraft Maintenance Manual (AMM), the automatic flight idle stop has two solenoids that operate a movable lock lever on the engine throttle controls. The solenoids are attached to a lever assembly on each engine (see Figure 1.6.3.3).

The solenoids are de-energized in flight to engage the lock lever and to prevent movement of the controls to a position below flight idle.

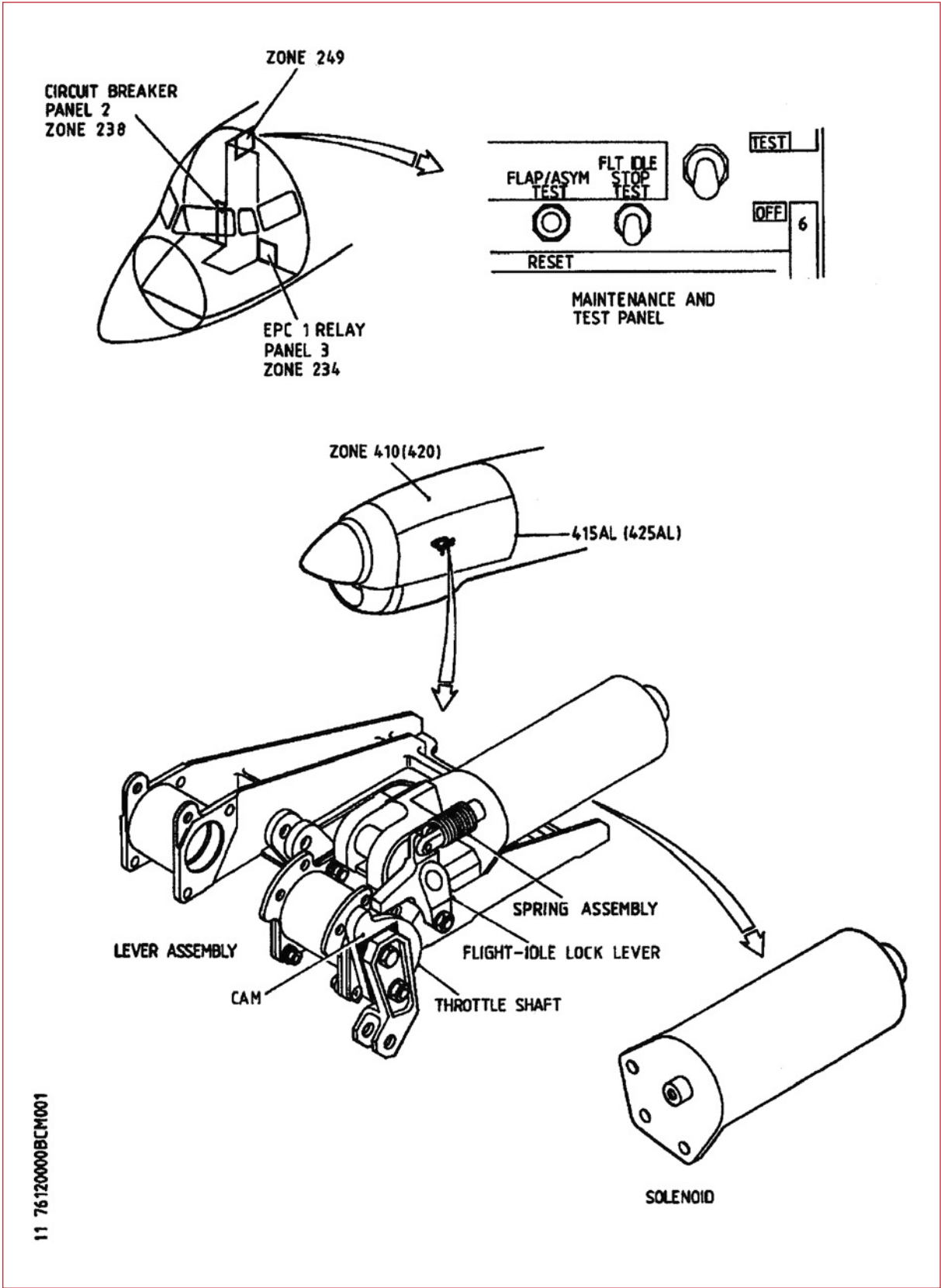

Figure 1.6.3.3. Detail of the automatic flight idle stop assembly (from Fokker Maintenance Manual)

When the aircraft is on the ground, the solenoids are energized either by the wheel spin-up signals or by the ground/flight switches to disengage the lock lever and permit full movement of the power levers.

When the aircraft makes a landing, a wheel spin-up speed of 20 mph or more sends an electrical supply through the skid control unit to energize the ground control relay.

The main landing gear air/ground switches also send an electrical supply to energize the ground control relay.

The air/ground signal that is recorded to the DFDR is taken from the left MLG leg. According to information provided by the manufacturer, during landing the switch is activated at a small deflection of the MLG. The switch unit is adjusted in such a way (ref. AMM 32-63-01-400-814A) that the ground signal is generated at a MLG deflection of 38 mm (1.5 in). The 38 mm depends on the kinematics only. If properly serviced, the pre-charge of the main gear is 210 psig nominal. In the manuals this is specified with a tolerance from 202-218 psig.

When the ground control relay is energized, it completes the supply circuit to energize both solenoids, which pull on the spring assembly to turn the flight idle lock lever away from the cam on the throttle shaft.

The ground control relay operates quickly (in milliseconds) and remains energized for a minimum of 16 s to cover the case of wheel skid or bounce conditions during landing.

When the aircraft takes off, the process reverts to push the spring assembly and the flight idle lock lever engages with the cam to avoid movement of the power control below flight idle.

The electrical system of this aircraft is protected by a 7.5 A circuit breaker located in the CB panel of the cockpit (behind the copilot seat). The circuit breaker is labelled «FLIGHT IDLE STOP SOLENOID 1 & 2».

1.6.3.1.3. *Modifications associated with the flight idle stop system*

There was a history of certain malfunctions of the automatic flight idle stop mechanism that made either impossible the selection of ground idle on ground after landing or possible the selection of ground idle in flight.

Originally, the flight idle stop system was installed on the pedestal. However, it had a potentially unsafe feature that could result in ground beta mode selection in flight. Therefore, beginning with aircraft s/n 20136, the system was relocated to the engines as described in the previous paragraph.

Later on, the manufacturer issued the «Service Experience Digest» (SED) 76-12001 (Rev. 2 dated Dec.-1991), in which it was mentioned that several operators with the relocated automatic flight idle stop had reported that during landing the power levers could not be retarded below that setting. The subsequent investigation revealed that it could be due to the contribution of the following failure modes:

- Blockage of the cam against the lock-lever (due to insufficient gap between them).
- Solenoid malfunction with subsequent tripping of the flight idle stop circuit breaker.

The manufacturer issued Service Bulletins SBF50-76-008 and SBF50-76-009 (which included a mechanical modification with new lock-lever, lever, spring and solenoid bracket) to ensure proper mechanical operation of the system. Later on there were two revisions to SB -009 and the issue was considered closed.

Aircraft PH-FZE had complied with both SB -008 and -009.

In December 1991, the manufacturer issued SED 76-12002, which also described the problem of impossibility of selection of ground idle after landing and discussed the failure mode of a solenoid malfunction with subsequent tripping of its circuit breaker, caused by unreliable microswitch operation (the other malfunctions were discussed in the previous SED 76-12001).

The solution proposed by Fokker was to introduce a time delay relay and resistors. SBF50-76-010 was issued to cover this modification.

Aircraft PH-FZE had complied with this SB -010.

However, a number of failures of the new introduced time delay relay were reported and the manufacturer issued SED 76-12003 (Rev. 1 dated Apr/94) where it was mentioned that those faults were due to the instantaneous current exceeding the maximum allowed contact rating of the new relay, which made the solenoids to continuously operate on a high current for which they were not designed that could finally lead to their failure with the inability to select ground idle after landing. The solution proposed by the manufacturer with SBF50-76-013 was to introduce a wiring change in the electrical power centre to ensure that the current was within the maximum allowed contact rating of the relay.

Aircraft PH-FZE had not complied with this SB -013.

In December 1994 the Service Letter 137 was issued by Fokker to remind the use of both flight idle stops (primary or mechanical and secondary or automatic). It was mentioned that the ground range selector levers should not be touched until nose wheels touchdown had occurred during landing, because otherwise two problems could happen:

- In-flight selection of ground idle if the automatic stop fails.
- Impossibility of release of the automatic stop after touchdown because of the friction caused by the power levers leaning against that secondary stop.

It was also stated in that Service Letter that the solenoids could inadvertently be energized for 16 seconds in flight after landing gear down selection without the knowledge of the crew. The solution to this problem was to modify the skid control unit to P/N 6004125-1 through the Aircraft Braking Systems Corporation (ABSC) Service Bulletin Fo50-32-24, with revision 2 issued in June 1994.

Aircraft PH-FZE had not complied with this SB 32-24, and its skid box was P/N 6004125, s/n FEB89-0075.

1.6.4. *Normal, abnormal and emergency procedures related to the brake system*

1.6.4.1. Normal procedures

The normal procedures of the AFM (5.03.01, version 02, issue 004) indicate that the runway threshold must be crossed at approx 50 ft and at Vref. The flare must reach a slightly nose-up attitude and the power levers retarded to idle. After nose landing gear touchdown, the pilot must select ground idle and use reverse as required.

The following page of the AFM states that reverse should not be applied before the nose landing gear is on the ground. A similar statement was in the AOM 7.05.01, page 3, version 01, issue 009 (Flight techniques. Approach and landing). Also in part 7.07.01 (version 05, issue 004) it is described that «Premature attempt to select ground idle just before touchdown may block the automatic flight idle stop release mechanism. Therefore if ground idle cannot be selected after touchdown, momentarily move the power lever(s) slightly forward to enable the automatic flight idle stop(s) to be released, and then reselect ground idle. If it is still not possible to select ground idle:

- Select TO rating on ERP as soon as possible
- Use brakes to slow down the aircraft
- Aim for the next exit available
- Clear the runway and stop the aircraft [...]

There is a NOTE in the same part of the AOM that says:

- «1. Landing distance will increase due to positive engine power during rollout (power is in TO rating). Actual landing distance is well within the normal required landing distance for flaps 25°.

2. The brakes will become hotter than during normal landing. When taxiing is continued in this condition brakes will heat up very quickly and may cause flat tyres. [...]»

1.6.4.2. Abnormal procedures

The Operations Manual prepared by the manufacturer only includes two abnormal procedures related to the brake system:

- Skid control fault, indicated by double chime, master caution light, and SKID CTL light. In this case, skid control is not available and brakes must be applied carefully to prevent blown tires. The landing distance without skid control is 1.86 times the distance for flap 25.
- Normal brake system failure, indicated by brake pressure indication low. In this case, alternate brakes must be applied. Skid control is not available and brakes must be applied carefully to prevent blown tires.

None of them is directly related to the circumstances of the Melilla accident, because no light appeared in the cockpit according to the statements of the crew.

The AOM also mentioned (Section 7.07.01, page 7) that, after failure of ground idle selection after landing, TO rating should be selected as soon as possible, and brakes used to slow down, clear the runway and stop the aircraft.

In AOM Section 4.11.04 (page 1, version 01, issue 006), Abnormal Procedures, it is stated that in case of normal brake system failure, alternate brakes should be applied carefully to prevent blown tires. It is not stated anywhere in the AFM or the AOM that the tires will necessarily blow if alternate brakes are used.

1.6.4.3. Emergency procedures

Neither the AFM nor the Operations Manual prepared by the manufacturer contained emergency procedures related to brake system malfunctions or failure to select propeller ground idle/reverse on ground.

1.6.4.4. Intentional use of go-around rating during approach

The use of GA rating during approach is not an unapproved or forbidden practice, actually on aircraft not modified in accordance with SBF50 73-010 this is considered to be a standard operating procedure. It is considered to be a resource to create additional drag that helps the aircraft to descend when the propeller goes to 100% rpm at the normal approach torque level and speed.

1.6.5. *Previous maintenance on the aircraft*

The maintenance records of the aircraft were reviewed and the following relevant information, in chronological order, was retrieved:

SQUAWKS RELATED TO THE BRAKE AND PROPELLER SYSTEMS	
Date	Maintenance item
11-06-2002	Antiskid inboard reported unserviceable. Item on Hold Item List (HIL).
17-06-2002	Replaced RH dual skid control valve and replaced wire harness on speed sensors LH/RH. Test OK. Hold item cleared.
18-06-2002	During a 3-day inspection, anti-skid inboard light was found illuminated. Transferred to HIL.
18-06-2002	Inboard and outboard speed sensors are changed and the problem is the same. Installed old speed sensors. Replaced brake shutoff valve and the problem is the same.
19-06-2002	Replaced RH wire harness. Checked OK. Hold item cleared.
09-07-2002	Wheel n° 2 replaced.
14-07-2002	Wheel n° 4 found out of limits. MLG wheel n° 4 replaced.
18-07-2002	Brake assembly n° 4 found out of limits. Brake assembly n° 4 replaced.
18-07-2002	Brake assembly n° 3 found out of limits. Brake assembly n° 3 replaced.
18-07-2002	Wheel n° 3 found out of limits. MLG wheel n° 3 replaced.
30-07-2002	RH propeller shaft seal leaking. Propeller removed and installed again to replace the seal.
26-08-2002	LH propeller replaced because propeller slip ring was worn.
13-09-2002	Wheel n° 4 found out of limits. MLG wheel n° 4 replaced.
07-10-2002	Removed RH propeller for shop repair.
14-10-2002	Aircraft changes registration from EC-HUB to PH-FZE.
14-10-2002	Another RH propeller installed.
25-10-2002	Wheel n° 3 found out of limits. MLG wheel n° 3 replaced.
12-11-2002	Bird strike on RH propeller. Checked propeller assembly, nacelle and fuselage for damage.
14-11-2002	During transit check MLG wheel n° 2 found with several cuts out of limits. Wheel n° 2 replaced.
21-11-2002	One time inspection of the antiskid control box performed.
25-11-2002	Replaced MLG wheel n° 1.
14-12-2002	N° 1 brake assembly found worn out. Replaced n° 1 brake assembly.
24/25-12-2002	LH MLG strut is approx. 6 cm higher than the RH one. Strut servicing checked and found OK.
26-12-2002	LH MLG strut again higher than RH strut. During takeoff and landing the aircraft «falls» to the right. RH strut servicing checked on ground and OK.
04-01-2003	During landing antiskid warning on CAP. Disappears during taxi. Operational test passed OK.
04-01-2003	MLG wheel n° 4 worn out. Replaced wheel n° 4.
17-01-2003	Accident flight

Technical report A-002/2003

SQUAWKS RELATED TO AIRSPEED INDICATORS (ASI)	
Date	Maintenance item
22-07-2002	8 kt of difference between both airspeed indicators. ASI indicator replaced and checked for leaks.
23-07-2002	Continues 5 kt of difference between both ASI. Difference found within limits according to Fokker SL 075.
14-09-2002	Left ASI marks 8 kt below. ASI replaced. Leak test performed and found OK.
20-11-2002	ASI difference of 5 kt at all speeds. Cleaned pitots, checked on ground and found OK.
21-11-2002	ASIs checked in flight and RH ASI is 5 kt higher. Left static coupling to ASI retightened.
21-11-2002	Problem persists. ASI replaced. Leak test performed and OK.
22-11-2002	Problem persists.
29-11-2002	Still difference of 5 to 7 kt. LH indicates less; standby indicator in the middle.
03-12-2002	Replaced LH ASI.
17-01-2003	Accident flight (during the cruise, the crew stated that there was a difference of 5 kt between ASIs).

The maintenance centre of the aircraft also provided the following list of the replacements of tires (in year 2002) and brake assemblies (in years 2001 and 2002) on the aircraft, to determine whether an abnormal wear had occurred on any wheel.

WHEEL N° 1					
Year	Month	Day	Reason	TSI	CSI
2002	01	21	WORN OUT	556	655
2002	03	08	HOLE	254	297
2002	06	07	WORN OUT	375	538
2002	09	10	WORN OUT	345	514
2002	11	25	WORN OUT	400	454

WHEEL N° 2					
Year	Month	Day	Reason	TSI	CSI
2002	03	08	WORN OUT	564	645
2002	05	17	WORN OUT	267	394
2002	07	09	WORN OUT	282	384
2002	09	27	WORN OUT	247	411
2002	11	14	CUTS ON RUBBER	247	244

WHEEL N° 3					
Year	Month	Day	Reason	TSI	CSI
2002	01	21	WORN OUT	573	683
2002	05	09	WORN OUT	488	635
2002	07	18	WORN OUT	361	520
2002	10	25	WORN OUT	305	443

WHEEL N° 4					
Year	Month	Day	Reason	TSI	CSI
2002	01	17	WORN OUT	453	524
2002	03	13	WORN OUT	292	338
2002	05	17	TYRE WORN OUT	251	373
2002	07	14	OUT OF LIMITS	306	428
2002	09	13	WORN OUT	165	262
2003	01	04	WORN OUT	599	661

BRAKE N° 1					
Year	Month	Day	Reason	TSI	CSI
2001	02	08	TO SERVE PH-PRI	1,059	770
2001	03	31	HYDRAULIC LEAK	154	135
2001	11	20	WORN OUT	1,085	1,209
2002	06	07	WORN OUT	948	1,195
2002	12	14	WORN OUT	869	1,081

BRAKE N° 2					
Year	Month	Day	Reason	TSI	CSI
2001	02	07	TO SERVE PH-DMC	930	680
2001	10	23	WORN OUT	1,091	1,168
2002	03	27	WORN OUT	790	932
2002	09	18	OUT OF LIMITS	695	1,035

BRAKE N° 3					
Year	Month	Day	Reason	TSI	CSI
2001	06	27	OUT OF LIMITS	1,774	1,480
2002	01	24	OUT LIMITS	913	1,047
2002	07	18	WORN OUT	829	1,135

BRAKE N° 4					
Year	Month	Day	Reason	TSI	CSI
2001	07	10	WORN OUT	1,839	1,535
2002	02	23	WORN OUT	1,002	1,189
2002	07	18	WORN OUT	676	938

1.6.6. *Loadsheets of the aircraft*

Before departure, the flight crew had been provided with a computerized loadsheet that supposed a payload of 1,100 kg and a landing weight of 17,007 kg (maximum is 19,730 kg). Later on, a «Load Instruction Report» (LIR) was signed and was supposed to include the actual weight at the moment of chocks off in Malaga. This report included 14 passengers (total weight of 1,176 kg at 84 kg each) and their 15 bags (165 kg) together with 392 kg of cargo (i.e., 557 kg of total cargo). The check in accounted for 10 passengers in the forward part of the cabin (the first 22 seats) and 4 passengers in the rear part of the cabin (the latest 28 seats).

However, there were last minute changes of the cargo to be carried, including the fact that the third person in the cockpit was not yet accounted for. A total of 153 kg of load were left out for another flight (this fact was checked with the customs records and there were 153 kg of cargo of flight ANS 8276 that were carried in another flight next day).

Therefore, shortly before takeoff the LIR was amended by hand to 218 kg in the forward cargo bay and 174 kg (in «15 pcs») in the aft cargo compartment.

After the crash in Melilla, the aft cargo bay was unloaded by the rescue personnel and the actual weight was not measured, although the figure of 174 kg in that rear compartment is considered accurate because the statements gathered pointed out that it had «eight to ten bags and four to five packages of low weight».

The load of the forward cargo bay was weighed and it was noted that its weight was 240.5 kg (higher than the 218 kg figure of the LIR because two bags of the cabin crew were loaded there).

In summary, it is estimated that the aircraft had an actual landing weight of

	13,968 kg (Dry Operating Mass) + 85 kg (third crew member)
	1,176 kg (14 passengers)
	414 kg (cargo)
	2,050 kg (fuel)
Total	<u>17,693 kg</u> (maximum allowed landing weight is 19,730 kg)

The actual cg at landing in Melilla was estimated to be 36.5% MAC (rearmost cg position at 17,000 kg is 40%).

1.7. Meteorological information

The METAR's of Melilla Airport at the relevant UTC times are as follows:

- 10:30 h: Wind 290° at 10 kt, 210V290, visibility more than 10 km, few clouds at 3,600 ft, temperature 17 °C, dew point 6 °C, QNH 1,029 mb.
- 11:00 h: Wind 240° at 10 kt, visibility more than 10 km, few clouds at 3,900 ft, temperature 19 °C, dew point 8 °C, QNH 1,028 mb.
- 11:30 h: Wind 260 at 12 kt; 230V300, visibility more than 10 km, few clouds at 3,600 ft, temperature 16 °C, dew point 7 °C, QNH 1,028 mb.

The accident happened at 11:00:01 h. At the moment of clearance to land on runway 15, the ATC provided the crew with the information: «Wind 240 12 kt, varying between 210 and 330».

The runway was completely dry.

The forecast for Melilla, valid from 6:00 h to 24:00 h of Friday 17 January 2003 indicated few clouds, except some cloudy intervals first time in the morning. Temperatures moderately rising. Gentle Westerly winds, with intervals of strong wind. Maximum forecast temperature: 14 °C.

The runway 15 threshold instantaneous wind record taken by the Meteorological Office of Melilla was reviewed. At 11:00 h, no instantaneous example of wind speed was above 18 kt and the mean value was around 13 kt. The mean value of the recorded wind direction was around 240° (see Figure 1.7.1). This meant almost pure crosswind. Wind direction above 240° meant some component of tailwind. It can be seen that around 11:00 h the wind direction mean value is 240° or less.

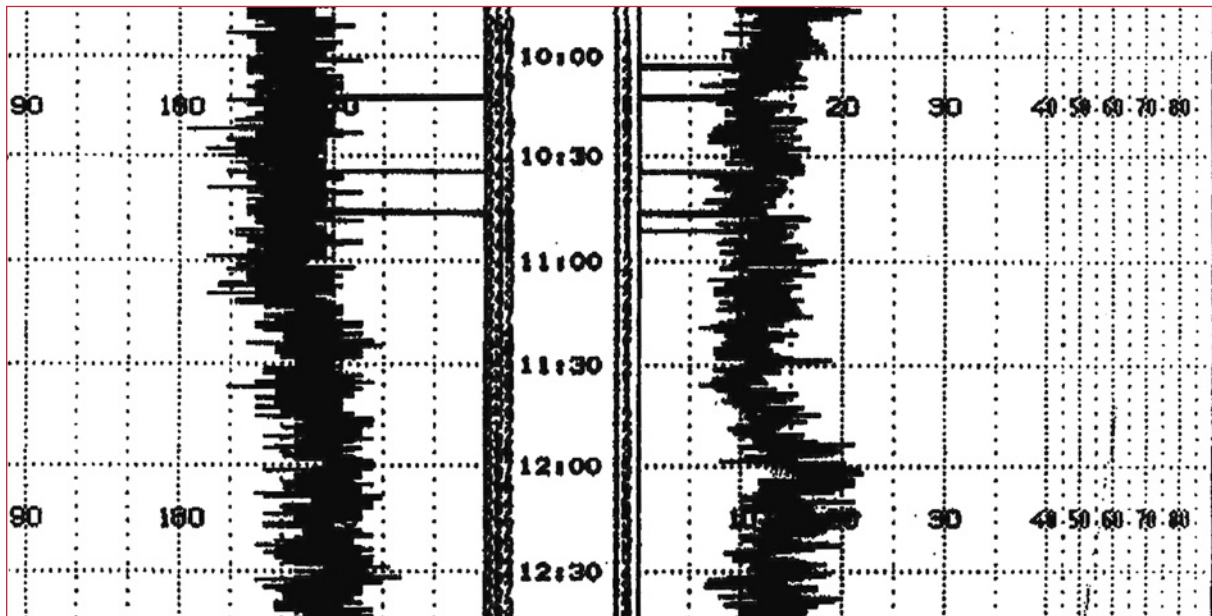

Figure 1.7.1. Instantaneous wind record runway 15 of Melilla Airport on 17-1-2003 between 10:00 h and 12:30 h UTC. On the left the wind direction in degrees is shown. On the right part of the graph, the wind speed in kt is recorded

1.8. Aids to navigation

The aids to navigation were operative and operated properly during the accident. There is a VOR and a DME (MEL) and a NDB with another DME (MLL). The visual precision approach system (PAPI) of runway 15 is set at 3.3° of glide path. The PAPI of runway 33 is set at 3°.

1.9. Communications

Communications between the aircraft and the ATC control were held without any technical problem. They were recorded both by the ATC tower in Melilla and by the CVR, and they have been used in several parts of this report.

1.10. Aerodrome information

Melilla Airport (GEML) has a single runway 15-33. It has no taxiways and there is an exit towards the civil apron. This exit may be used as a high speed exit when landing on runway 15 provided the aircraft has conveniently reduced the speed during the landing roll. Landing on runway 33 implies to reach the end of that runway to turn around and backtrack using the runway as a taxiway.

Runway physical dimensions are 1,347 × 45 m. Threshold 15 is displaced, and at the time of the accident, landing distances available (LDA) were: 1,347 m (runway 33) and 1,082 m (runway 15). At the end of runway 15 the terrain falls in a deep embankment

with a height of around 15 m. The runway strip was 1,440 m × 150 m on both runways. Runway 15 had a declared stopway of 33 m × 45 m. Annex 14 of ICAO (paragraph 3.3.2) states that «A strip shall extend before the threshold and beyond the end of the runway or stopway for a distance of at least: 60 m where the code number is 2, 3 or 4...» It is also recommended that the width of «A strip including a non-precision approach runway should extend laterally to a distance of at least: ... 75 m where the code number is 1 or 2». Melilla Airport has a code number 2.

According to the AIP dated 17-8-00 (see Figure 1.10.1), since this runway had a stopway, it would mean that there was no strip available at the end of runway 15.

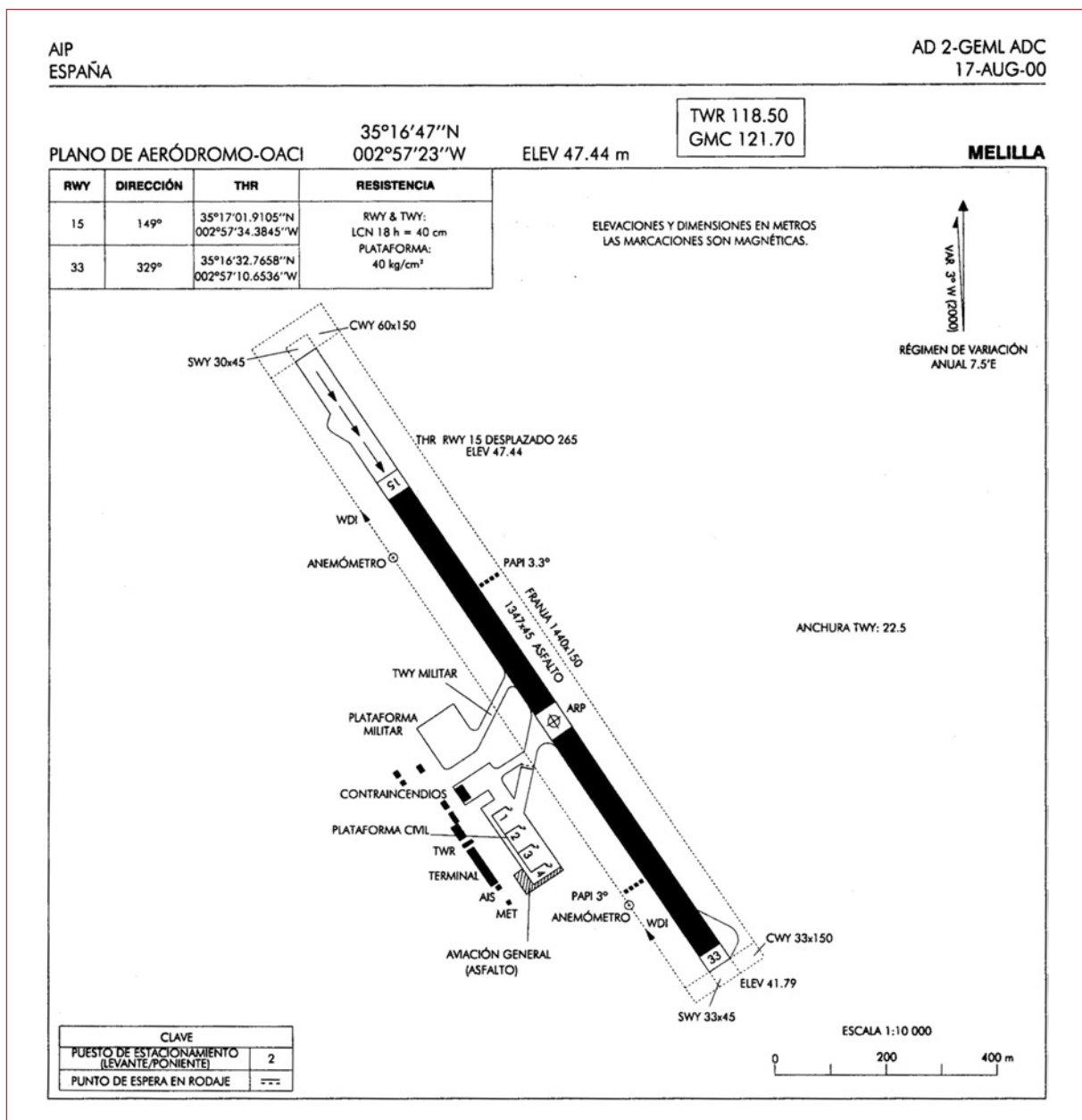

Figure 1.10.1. AIP revised in year 2000. At the end of Runway 15 there is a stopway of 33 m × 45 m

Technical report A-002/2003

Some inquiries were made regarding the suitability of the strip at Melilla Airport and in October 2003, the AIP was amended and any reference to a stopway in runway 15 was deleted. It was stated that the runway strip extended 33 m × 80 m beyond the end of runway 15. However, this strip did not yet comply with the recommendations of Annex 14 of ICAO, which required a strip of 60 m of length and recommended 150 m of minimum width for such a strip (see attached Figure 1.10.2).

The airport had no refuelling facilities. The category for fire-fighting purposes was 5 and there was no rescue equipment. Therefore, the maximum aeroplane overall length was 24 to 28 m and the maximum fuselage width was 4 m.

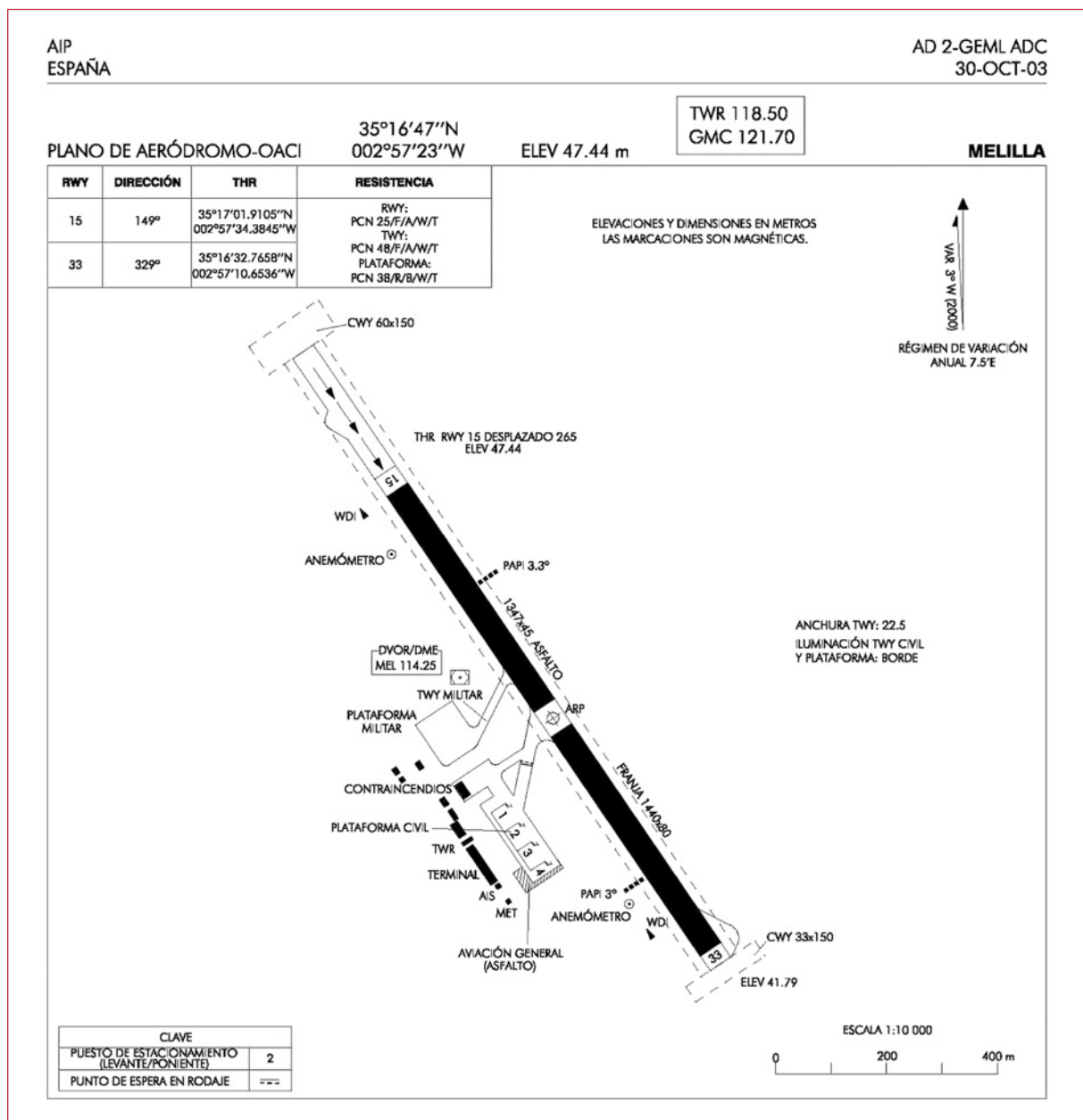

Figure 1.10.2. AIP revised in October 2003. At the end of Runway 15 there is no stopway

Some aircraft models that operated or had operated on the airport are: ATR 42, Dash 8-300, BAe 146, and CASA CN-235.

The runway braking coefficient was tested on 27 November 2002. The following values of «Mu» were obtained for runway 15 (i.e. from 15 threshold towards 33 threshold):

	1st third of the runway	2nd third of the runway	3rd third of the runway
3 m to the right (of the centreline)	0,71	0,72	0,72
3 m to the left (of the centreline)	0,70	0,69	0,72

Annex 14 of ICAO recommended the following values of «Mu»: 0.72 for new runways; between 0.52 and 0.42, analyse causes and correct; below 0.42, correct immediately.

The runway surface texture was also measured and the result was 1.050 mm (compared with 1.000 of minimum average runway texture depth recommended by Annex 14 of ICAO, paragraph 3.1.24).

The test results report considered those results satisfactory.

1.11. Flight recorders

1.11.1. Cockpit voice recorder

The aircraft had a cockpit voice recorder Fairchild A-100A, P/N 93-A100-80, S/N 62184 (date 02/95). This CVR, located in the rear of the air conditioning bay (rear of the aircraft), records 30 minute of four audio input signals on a four-track magnetic tape at the same time, through their respective record heads. The four channels are:

- Channel 1: contains an encoded time data for synchronization with the DFDR
- Channel 2: contains the audio from the first officer's position
- Channel 3: contains the audio from the captain's position
- Channel 4: contains the ambient audio in the cockpit from the area microphone, which is located in the overhead panel in the cockpit.

The CVR was recovered on the same day of the accident and later on it was replayed. The sound had an acceptable quality and the relevant conversations and cockpit sounds were identified in the initial sessions. Later on, a detailed frequency analysis was carried out by the BEA laboratory to try to identify specific sounds related to the circumstances of the accident.

1.11.1.1. Relevant CVR data

Only the summary of some conversations are included here. During the whole flight there were a lot of conversations in the cockpit related to general aspects of the operation to Melilla Airport for the benefit of the two co-pilots on board.

Three columns with time are included to see the synchronization values used. There was less than a second of difference in most of the conversations between the ATC communications record and the CVR. The DFDR clock was approximately 14 sec delayed with respect to the ATC communications clock. CM means a crew member is talking. CM1 means the pilot in command and CM2 means the copilot.

CVR time (reference: first contact with TWR) (hh:mm:ss)	ATC time (hh:mm:ss)	DFDR time (reference: GPWS warnings) (hh:mm:ss)	DFDR comment	Station talking	Text
10:51:23				CM	We'll get a wind check when we are about three or four miles on final. If the wind is 260 at seven we'll make straight into runway 15; if it is a little stronger, then we'll go around, in any case we'll land with flap thirty five
10:53:44	10:53:43	10:53:27		ATC	Air Nostrum 8791 Melilla, buenos días, roger, you are number two; number one is a company traffic, Fokker 50 proceeding from Malaga now is in radial 322, 24 miles out of the field, and thru 100
10:54:11	10:54:11	10:53:54		ATC	8791, the runway in use 33, we have wind 250 12 knots, visibility more than ten, few at three thousand six hundred, temperature 15, qnh one zero two eight
10:54:35	10:54:34	10:54:18		ANS8791	Roger it's all copied, 8791, there will be any chance for runway one five we take that.
10:54:43	10:54:43	10:54:26		ATC	8791, did you request runway one five?
10:54:48	10:54:47	10:54:31		ANS8791	Affirm, if no possible to the traffic it's no problem, we can take one five Melilla
10:54:55	10:54:54	10:54:38		ATC	I'll tell the number one. Number one is going to three three, in that case you have to go to three three, any way I can ask the other traffic if he admits runway one five.
10:55:17	10:55:17	10:55:00		ATC	Ok Air Nostrum 8276, tower there is a second traffic behind of you that would prefer to take in runway one five, in that case you will have to proceed to one five, will you admit runway one five or you prefer three three?

CVR time (reference: first contact with TWR) (hh:mm:ss)	ATC time (hh:mm:ss)	DFDR time (reference: GPWS warnings) (hh:mm:ss)	DFDR comment	Station talking	Text
10:55:58	10:55:57	10:55:41		ATC	8276 did you copy me?
10:56:00	10:56:00	10:55:46		CM	Negative, Air Nostrum 8276
10:56:03	10:56:02	10:55:46		ATC	8276 I inform you there is another company traffic behind of you, it is number two and he would prefer to use runway 15, if he can use runway 15 you'll have to take 15 as well
10:56:20		10:56:03		ATC	So would you admit to use 15 or do you prefer to keep on runway 33?
10:56:26	10:56:25	10:56:09	10:56:09 xmit for 4 seconds	CM	Uhh, we can uuh, accept, accept runway 15, air nostrum 8276
10:56:30	10:56:30	10:56:13		ATC	Air Nostrum 8276 In that case proceed to runway 15 the wind 250 11 knots
10:56:38	10:56:36	10:56:21	10:56:20 xmit for 5 seconds	CM	Uhhh copied the winds and clear to proceed to runway 15, air nostrum 8276
10:56:43	10:56:42	10:56:26		ATC	Air Nostrum 8791 number one has accepted runway 15, so in that case you proceed to runway 15, I'll give you the traffic information, now he is 12 miles out of the VOR, radial 330 altitude 6000 feet
10:56:58	10:56:57	10:56:41		ANS8791	Roger, we will be looking out for the traffic we are reducing speed for separation, 8791 eeh requesting further descent
10:58:04		10:57:47		CM	Runway in visual
10:58:08		10:57:51	3910 ft	CM	We are a little bit high
10:58:28		10:58:11		CM	And I'm going to lose a little bit of altitude this way
10:58:33		10:58:16		CM	I'm high so I am to take the gear down
10:58:36		10:58:19		CM	«Gear down»
10:58:36		10:58:19		SOUND	Noise of landing gear lowering
10:58:45		10:58:28		CM	«And I'll take flap 25, landing check»
10:58:48		10:58:31	Flaps extending	CM	«Flaps 25»
10:59:02		10:58:45		CM	«And I am going to do an S turn to lose a little bit of altitude»
10:59:10	10:59:09	10:58:53		ATC	Air Nostrum 8791 number 1, five miles out through 3,000 ft
10:59:16	10:59:15	10:58:59		8791	Ok is copied, 8791
10:59:36		10:59:19		CM	«Flaps 35»

Technical report A-002/2003

CVR time (reference: first contact with TWR) (hh:mm:ss)	ATC time (hh:mm:ss)	DFDR time (reference: GPWS warnings) (hh:mm:ss)	DFDR comment	Station talking	Text
10:59:37		10:59:20	10:59:21 flaps extending to 35	CM	«Flaps 35»
10:59:39		10:59:22	Radioheight 1,463 ft; altitude fine 1,546 ft	CM	«It's a little bit early for it, but we are high»
10:59:44		10:59:27		CM	«Check»
10:59:45		10:59:28	10:59:34 flaps at 35°	CM	«Flaps 35 sets»
11:00:10		10:59:53		GPWS	Sink rate, sink rate (for 2 seconds)
11:00:11		10:59:54		CM	«Disregard»
11:00:12		10:59:55		CM	«Check»
11:00:12		10:59:55	10:59:56 rpm of prop 1 and 2 at 85%, and start increasing	CM	If you can give me go around power that will...(ATC starts talking)
11:00:14	11:00:13	10:59:57		ATC	«Air nostrum 8276 you are cleared to land on runway 15 the wind 240 12 knots varying between 210 and 300»
11:00:18		11:00:01		GPWS	Sink rate, sink rate (in between the ATC talking)
11:00:23	11:00:22	11:00:06	11:00:04 torque starts increasing	CM	«Clear to land runway 15, copied the wind Air Nostrum 8276» (increase of power can be heard)
11:00:24		11:00:07		GPWS	Sink rate, sink rate (in between the CM talking)
11:00:29		11:00:12	rpm prop 1 and 2 at 100%	SOUND	RUUUUUU (increase of the speed of the prop)
11:00:29		11:00:12		GPWS	Sink rate, sink rate (after the warning, it seems power is applied and then levers retarded to idle again)
11:00:31		11:00:14		CM	«It's bumpy»
11:00:34		11:00:17		CM	«Clear landing»
11:00:35		11:00:18		CM	«Check»
11:00:51		11:00:34		CM	«It's very bumpy»
11:00:54		11:00:37	First «ground» mode signal	SOUND	Touchdown sound; quite positive (almost exactly at 11:00:54,01)
11:00:55		11:00:38	air mode	SOUND	Clack, clack (brief sound)
11:00:56		11:00:39	air mode; 11:00:40 rpm prop 1 and 2 go to 85%. Parameter Standby (Flight Director) goes from 1 to 2	SOUND	Like cyclical wheel sound
11:00:59		11:00:42	air mode	CM	«I have no reverse» (not very nervous)

CVR time (reference: first contact with TWR) (hh:mm:ss)	ATC time (hh:mm:ss)	DFDR time (reference: GPWS warnings) (hh:mm:ss)	DFDR comment	Station talking	Text
11:01:02		11:00:45	Ground signal until the end of the recording	CM	Interjection. «No»
11:01:06		11:00:49	lat acceleration 0.107 (max value): speed 68.6 kt	SOUND	THUMP (noise)
11:01:06	11:01:05	11:00:49		ATC	«8791 the traffic is on land»
11:01:09	11:01:08	11:00:52		8291	«Ok thank you we will come on in now»
11:01:11		11:00:54	lat acceleration 0.089 (second max value): speed 61.7 kt	SOUND	CROCK (noise)
11:01:12		11:00:55	corrupted value in heading	CM	Interjection
11:01:14		11:00:57		CM	«Brace yourselves!»
11:01:16		11:00:59	Air mode. The DFDR recording ends	SOUND	Scratch noises
11:01:18		11:01:01		SOUND	Thump (noise)
11:01:19		11:01:02		CM	«Ah» (breath)
11:01:20		11:01:03		SOUND	CVR stops on the accident flight

1.11.1.2. Detailed analysis of a CVR sound

The CIAIAC asked the «Bureau d'Enquêtes et d'Analyses pour la Sécurité de l'Aviation Civile» (BEA) of France to analyse a sound of the CVR recording at their laboratory in Paris. The goal of analysis was compare a sound recorded immediately after the touchdown (at 11:00:55 h in the above transcript) with other known sound generated in normal operation of an aircraft of the same type when the power levers were moved to the ground idle position.

The BEA carried out that analysis and concluded as follows:

«The noises that we compared present several similarities in their shape, cadence and frequencies.

Some characteristic frequencies are common to each sound of the complete noise. A perfect match could not be obtained due to the multiple possibilities to move the throttle levers, the specificity of each aircraft, and the different background noises.

Immediately after this noise, two more noises are recorded. These could not be identified using our database. Our hypothesis is that the crew pushed partially back the levers in order to try to pull them back again in the ground idle position.

After these noises, a crewmember mentions the impossibility to engage the reverse on both engines.

Based on all these facts, we can conclude on a probable identification of the target noise as the motion of the throttle levers to the Ground Idle Position.»

This did not mean that the throttle reached the ground idle position, but that an attempt was made.

1.11.2. *Flight data recorder*

The aircraft was equipped with a digital flight data recorder (DFDR) Fairchild F-800, P/N 17M800-251, S/N 3333. The Flight Data Acquisition Unit (FDAU) was Teledyne P/N 2229765-3A.

This system records 25 h of a total of 103 parameters, allocated in frames of 64 words. The DFDR was recovered the same day of the accident and it was in good condition. The data were downloaded in a laboratory and Fokker Document R-AV89.123, Issue 2 (December 1991) was used to convert the recorded data into engineering units.

Most of the data were consistent, except for the following relevant parameters:

- Ground speed (no source data available).
- Control wheel position (invalid: values out of specified range by a factor of 6).
- Latitude position (no source data available).
- Longitude position (no source data available).

1.11.2.1. *Aircraft trajectory*

From the DFDR data, the aircraft trajectory from Malaga was obtained (see Appendix A), including a detail of the latest part of the approach to runway 15. Although the whole flight was almost straight forward to the runway, several S-turns could be observed in the final part of the approach.

1.11.2.2. *Flight parameters. Descent and final approach*

From the data retrieved, it was noted that the takeoff and the cruise part of the flight were normal. At 10:53:00 h the aircraft was descending through 12,000 ft at 224 KIAS and 85% of rpm of both propellers. From that point on, the following relevant data were observed:

DFDR UTC time	Radio-altitude (ft)	Airspeed (KIAS)	Approx. prop LH rpm (%)	Roll angle (degrees; positive means right wing down)	Flap position (degrees)	NOTE
10:58:33	2,637	160.3	85%	8.9°	17°	Starts roll input
10:58:48	2,391.6	147.1	85%	26.1°	27°	Reaches the maximum roll angle to the right in this manoeuvre
10:59:05	2,097	136.4	85%	-29.4°	27°	Reaches the maximum roll angle to the left in this manoeuvre
10:59:21	1,514.5	139.7	85%	4.9°	28°	Initiates again roll to the right
10:59:28	1,263.5	138.1	85%	32.6°	35°	Reaches the maximum roll angle to the right in this manoeuvre
10:59:52	631.2	134.8	85%	-18.1°	36°	Reaches the maximum roll angle to the left in this manoeuvre. (Between 597 and 227 ft a total of four GPWS 1 warnings are generated)
10:59:59	426.1	129.4	85.8%	-8.8°	36°	Propeller 1 and 2 speeds start increasing
11:00:03	501.9	129.6	100.7%	6.2°	36°	Propeller 1 reaches 100% rpm
11:00:28	108.1	121.4	99.1%	4.1°	36°	Propellers 1 and 2 start decreasing speed. Since 11:00:03, roll angle has gone to -10.2° and then back to 4.1°

The approach was very unstable, including the vertical speed, as it can be seen in Figure 1.11.2.2.1. There were four «SINK RATE» warnings of the GPWS (see Figure 1.11.2.3.1) because of the high vertical speed and they were disregarded.

1.11.2.3. Flight parameters. Touchdown and landing roll

The touchdown and landing roll were studied in detail. Some graphs have been included in Appendix D. A table with the values of the most relevant parameters from 11:00:29 h UTC (aircraft at 47.2 ft of radio altitude) to 11:00:59 h UTC (the DFDR stops recording values) is included below. Parameters corresponding to second XX must be interpreted as «recorded between second XX and second XX + 1 at some point, depending on the subframe word where the parameter is recorded» (there are 64 words in every subframe, i.e. in every second).

The sign convention is as follows:

- Pitch: positive sense is nose up. It is recorded once per second, in word 36 of every subframe.
- Roll: positive sense is right wing down.
- Heading: positive sense is clockwise from North.

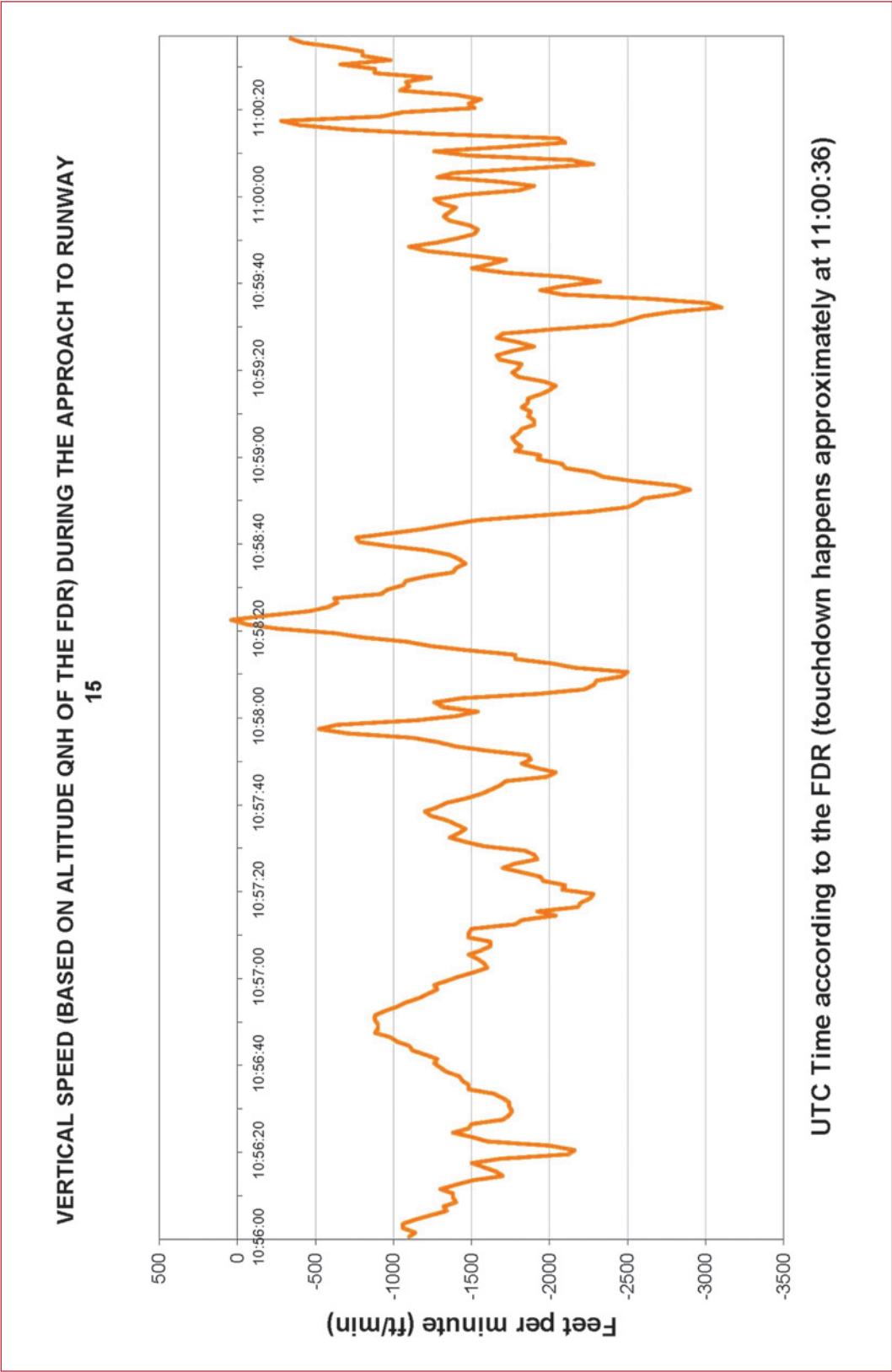

Figure 1.11.2.2.1. Vertical speed. Around 15 seconds before touchdown the vertical speed was between 1,500 and 1,000 fpm

- Control column: positive sense is aircraft nose up.
- Rudder position: positive sense is nose right (right pedal deflected). Rudder position is recorded two times per second (parameters «RUDD» and «RUDDA»). Maximum values are $+20^\circ$ and -20° .
- The discrete air/ground signal is recorded twice per second (in words 24 and 57 of every subframe) in the DFDR. The signal is taken from the left MLG leg. A compression of 38 mm (1.5 in) of the leg activates the air/ground switch.
- Radio altitude is recorded once per second (in word 33 of every subframe). Overall accuracy is ± 4.272 ft below 75 ft.
- Vertical acceleration is recorded eight times per second. Positive sense is acceleration up. Maximum and minimum values are $+6$ g and -3 g and the overall accuracy is 0.09 g.
- Longitudinal acceleration is recorded four times per second. Positive sense is forward. Maximum and minimum values are $+1$ g and -1 g and overall accuracy is 0.02 g.

As it can be seen on Table 1, at the beginning of the landing manoeuvre (at 50 ft) the airspeed was approximately 117 KIAS. An almost pure crosswind came from the right of the aircraft (240° , 12 kt, compared with 150° of aircraft heading) and therefore the right wing was down (6.9°) and the rudder was deflected 8.5° nose left in a crab manoeuvre. The left propeller speed was still at 99.1% while the right propeller was at 94.9% rpm. Pitch angle was 7.3° nose down, and was increased nose up until it reached -0.6° at 11:00:36.

A maximum of vertical acceleration of 1.329 g (parameter «vertical acceleration 3», because up to 8 vertical accelerations are recorded every second) was recorded at some point from the second 36th to the 37th. That would mean the maximum acceleration was reached approximately at 11:00:36.375 h (see vertical acceleration graph in Appendix D) and the airspeed was between 107.3 and 98.0 kt.

At some point between 11:00:36.500 h and 11:00:36.625 h, a radio altitude of -0.1 ft was recorded. Speed was between 107.3 and 98 KIAS at those moments.

At the same time, the roll was between 6.6° and 5° (right wing down) and the pitch between -0.9° and -0.6° nose down, and that means that the aircraft first touched the ground with the right MLG closely followed by the NLG. Then the roll angle changed to -2.9° (left wing down) and the left MLG also touched the ground, generating the «ground» signal (which is taken from the left leg of the MLG) recorded between 11:00:37,500 h and 11:00:38,000 h.

The aircraft had a speed between 98 KIAS and 101 KIAS when the ground signal was first recorded. The next 14 samples of that parameter were «air» again until at 11:00:45 h the signal changed to «on ground» and remained in that position for the rest of the landing roll until it jumped through the slope at the end of the runway.

Table 1. PH-FZE accident touchdown and landing roll
(second XX means 11:00:XX h UTC)

SEC	AIR	AIRA	ASPD KIAS	COLUMN deg	FF 1 lb/h	FF 2 lb/h	MHDG s	PITCH deg	RALT ft	ROLL deg	rpm 1 %	rpm 2 %	RUDD deg	RUDDA deg
29	1.	1.	117.6	-0.2	86.4	70.3	151.1	-7.3	47.2	6.9	99.1	94.9	-8.5	-8.6
30	1.	1.	129.4	-6.9	86.4	71.8	150.0	-3.2	32.3	4.4	99.7	94.5	-8.6	-8.5
31	1.	1.	119.2	-2.9	86.4	68.8	148.1	-4.7	23.8	3.0	99.7	93.2	-6.9	-7.6
32	1.	1.	115.3	-2.3	87.5	73.2	148.0	-3.0	15.5	3.3	98.4	91.3	-11.3	-10.2
33	1.	1.	119.5	-4.5	86.1	74.3	148.0	-1.1	9.7	3.4	97.7	90.7	-8.6	-11.0
34	1.	1.	117.6	-0.3	87.5	77.6	148.1	-2.3	6.6	3.8	97.6	90.5	-9.1	-12.3
35	1.	1.	108.8	-2.7	87.5	76.2	148.2	-0.9	3.8	6.6	96.4	88.6	-15.7	-15.7
36	1.	1.	107.3	-5.3	87.5	74.3	-174.9	-0.6	-0.1	5.0	94.7	86.6	-12.9	-8.8
37	1.	0.	98.0	-9.3	90.5	76.2	146.8	-2.0	-0.1	-2.9	93.9	86.0	-4.9	-4.1
38	1.	1.	101.1	-9.8	116.5	109.5	148.6	-1.8	-0.1	3.0	95.6	88.4	0.7	-10.2
39	1.	1.	93.0	-9.8	74.3	82.0	152.8	-1.1	-0.9	-0.9	92.1	86.3	-15.5	-4.8
40	1.	1.	95.5	-9.4	71.4	79.1	152.6	-1.5	-0.9	-0.4	88.4	84.1	-4.5	0.6
41	1.	1.	87.4	-9.9	71.4	74.3	150.4	-0.9	-0.1	-0.4	85.9	82.2	0.1	0.4
42	1.	1.	94.9	-9.1	77.3	76.2	149.0	-1.6	-0.9	-0.4	84.4	81.2	3.6	3.4
43	1.	1.	85.9	-9.3	77.3	76.2	149.0	-1.6	-0.9	0.2	82.9	79.9	1.5	0.2
44	1.	1.	82.0	-9.1	86.1	85.0	148.0	-2.1	-0.9	0.1	81.4	79.5	1.1	4.0
45	0.	0.	86.3	-8.5	83.5	86.4	147.8	-2.2	-2.0	-0.3	80.2	79.1	3.4	7.0
46	0.	0.	80.7	-7.4	90.8	90.5	147.0	-1.8	-0.1	-0.6	79.5	79.1	6.7	7.5
47	0.	0.	77.9	-4.0	91.9	91.9	147.0	-1.8	-0.1	-0.2	79.8	79.6	5.0	14.0
48	0.	0.	74.6	-5.8	90.5	90.5	147.0	-1.0	-0.1	-0.4	79.9	79.6	15.2	11.2
49	0.	0.	68.6	-4.6	93.8	94.8	147.0	-1.1	-0.9	-0.4	79.7	79.2	7.4	10.3
50	0.	0.	69.3	-0.8	95.2	100.7	-157.5	-1.2	-2.0	-0.6	79.5	79.2	16.4	14.4
51	0.	0.	65.9	0.7	89.4	99.2	149.0	-1.0	-0.9	-0.4	79.7	79.6	16.2	20.4
52	0.	0.	65.1	1.8	87.9	100.7	147.1	-0.4	-0.9	-0.5	79.7	79.5	21.7	21.1
53	0.	0.	63.5	0.8	89.4	106.6	148.4	-0.9	-2.0	-0.4	79.3	79.0	13.9	20.7
54	0.	0.	61.7	0.4	75.8	89.0	149.5	-0.9	-2.0	-0.4	76.5	74.9	20.4	21.3
55	0.	0.	61.3	0.4	58.6	67.4	149.8	-0.2	-2.0	-0.4	72.3	70.5	21.4	21.6
56	0.	0.	53.0	6.6	56.8	65.9	-157.5	-0.4	-2.0	-0.7	68.3	66.9	21.6	22.0
57	0.	0.	52.4	7.6	67.0	68.8	150.6	-0.8	-0.9	-0.4	65.5	65.0	22.5	22.4
58	0.	0.	49.6	5.4	75.8	68.8	146.0	-1.5	-2.0	-0.1	63.8	63.9	22.4	22.1
59	0.	1.	48.4	79.1	0.0	10.3	136.2	-90.0	-0.9	0.3	62.7	43.9	17.0	-156.4

For the purposes of this report, it was considered that the touchdown happened at 11:00:36,375 h (moment of maximum vertical acceleration with 1.329 g). It then took more than a second for the first «ground» signal to be recorded.

At the moment of touchdown with the RH MLG, the propeller speeds were 94.7% (left) and 86.6% (right) and continued descending until they were stabilised at around 80% approximately between seconds 44 and 53.

Afterwards, the speeds of the propellers descended towards approximately 65% (second 57).

The rudder, which was 12°-15° nose left before touchdown, came to neutral on second 41, and immediately started to be deflected in the nose right position until it reached the maximum 20° deflection around second 52, and was kept in that position until the end of the recording.

The recorded data also show that, after touchdown, there were some fluctuations of airspeed without a noticeable decrease. At second 42, speed was still 94.9 KIAS. Then, it decreased continuously, although deceleration was not very heavy. The aircraft jumped through the slope with 48.4 KIAS.

A vertical profile of the approach and touchdown can be seen in Figure 1.11.2.3.1. The approach path had an angle of 6° until the moment the aircraft was at 147 ft of radio-altitude. After that point, the glide path had an angle of around 3.4° up to the point the aircraft was at 15 ft and then the path changed to a very flat approach until touchdown.

1.11.2.4. Comparison of flight parameters with a previous flight

The same day of the accident, the aircraft had flown to Melilla with a different crew, and had landed on runway 15 at around 7:00 h UTC. The DFDR data of that landing were analysed and compared with the accident flight.

In Appendix D, approximate graphs comparing the speed, accelerations, pitch, column position and radio altitude have been included.

The following differences were noticed:

	Accident flight	Previous flight
Touchdown speed	Between 107 and 98 KIAS	Between 96 and 91 KIAS
Maximum vertical acceleration during touchdown	1.329 g	1.201 g
Pitch during touchdown	Approx. between -0.6° and -2.0°	Approx. 1.1° and 0.1°
Control column angle during touchdown	Approx. between -5.3° and -9.3°	Approx. between 3.4° and -0.9°
Left propeller rpm rate	Approx. 95%-94%	Approx. 80%
Right propeller rpm rate	Approx. 87%-86%	Approx. 74%

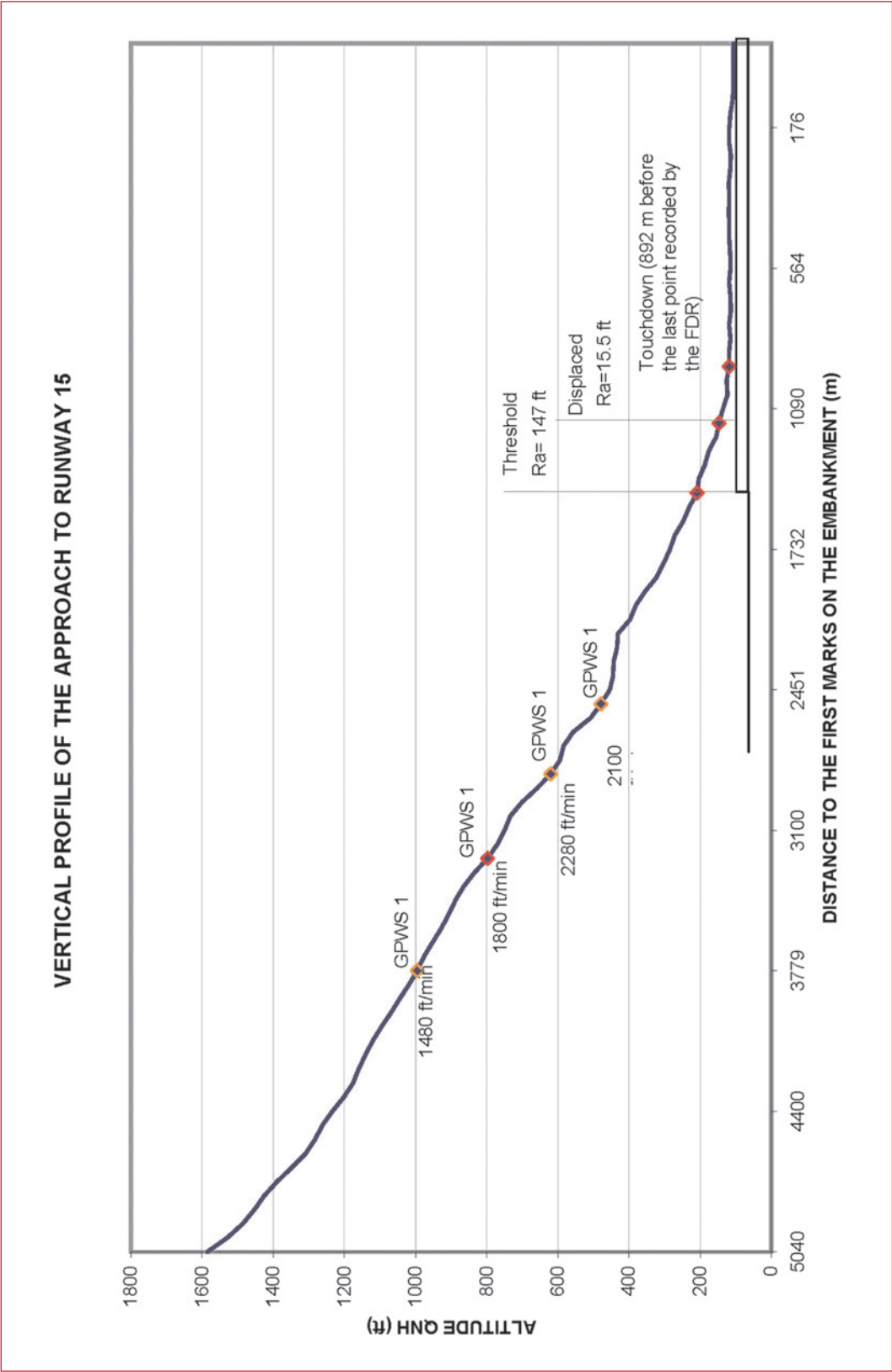

Figure 1.11.2.3.1. Vertical profile and landing rollout. The aircraft ran around 892 m from touchdown up to the end of the recording (impact with the terrain of the embankment)

The horizontal deceleration during the landing roll was noticeably different (see graph in Appendix D). The maximum value during the previous flight was -0.359 g, whereas during the accident flight it was stronger than -0.250 g only in a few samples.

1.12. Wreckage and impact information

1.12.1. *Runway tracks and marks in the terrain*

A drawing of the tracks and marks left by the aircraft on the runway and the surrounding terrain is presented in Appendix B, with some references to the photos included in Appendix C.

The exact touchdown point could not be noticed on the runway. At approximately 258 m from the 15 threshold, slight tracks of the four wheels were noted. Initially, it seemed the tracks corresponded to normal braking. Approximately 15 m afterwards, the track of wheel 3 started to darken, and after another 65 m there were clear signs that wheel 3 was blocked (see Photo 1 in Appendix C).

At 523 m from the runway threshold, the dark track of wheel 3 crossed the runway axis line (see Photo 2 in Appendix C).

Near runway edge light n° 9 (see numbering system in Appendix B) the wheel 3 track, which was dark with a «solid» nature, started to lighten, and after passing the level of light n° 8, the track became cleared in the centre, indicating a deflated tire.

When passing through the level of light n° 7, the tracks of wheels 1 and 2 became darker and therefore more noticeable.

At the level of runway edge light n° 2, the track of wheel 1 exited the asphalted surface of the runway, and the axis of wheels 1 and 2 broke the upper part of that light.

The track of wheel 4 became darker and the LH MLG continued rolling on the grass for a while until it entered the racquet of runway 33 threshold (see Photo 3 in Appendix C).

Half way through the racquet, the veering of the tracks increased noticeably to the left. Then the RH MLG tracks exited the racquet and shortly afterwards the tracks of the nose wheels also appeared on the grass.

At around 15 m from the end of the runway stopway, the track of wheel 3 also left the runway. At this zone, the transversal distance between the tracks of the nose wheels and each pair of main landing gear wheels indicated that the aircraft was skidding to the left. The track of wheel 4 on the grass was deeper than that of wheel 3.

The tracks of the three landing gear legs disappeared when the aircraft jumped through a slope located to the end of the clearway of runway 15 (see Photo 4 of Appendix C).

For a distance of 26.5 m along the slope (see drawing in Appendix B), there were no marks or tracks, until the nose wheels impacted again against the terrain and 5 m downwards short and deep tracks of the four wheels of the MLG could be seen and then two deep furrows of approximately 10 m by 1.5 m were probably produced by the rear part of the nacelles (see exact measurements in Appendix B and general view in Photo 5 of Appendix C). However, experts of the manufacturer that inspected the area after the accident considered highly unlikely that those furrows were produced by the rear part of the nacelles.

A few meters afterwards, other two furrows of approximately 5 m by 1.5 m were dug in the terrain. Approximately at the middle of those furrows, 7 blades were found buried. Other blades detached at those points and were thrown away. The path of those blades could be noticed in several areas of grass that were disturbed, although the blades themselves were collected and grouped by the rescue people after the accident.

After they appeared first time, the marks of both NLG wheels were noticeable all the way down the slope. At some point after the second pair of furrows, the marks merged into a single thick mark, indicating the NLG wheels had rotated and they were skidding rather than rolling.

The fuselage passed then over a trough and came to a stop.

1.12.2. *Wreckage layout*

The aircraft came to a stop after impacting against the perimeter fence of the airport. The front part of the fuselage, including door 1R and the RH main landing gear leg, ended outside the airport premises. The nose and RH MLG wheels had passed over the low concrete wall of the perimeter fence, and showed major damage.

The NLG was bent rearwards, and the wheel steering was rotated to the right. The wheel rims were heavily damaged and the tires deflated.

The RH MLG leg was extended and locked down. Both tires 3 and 4 deflated, and on wheel number 3 a big flat spot could be seen. The LH MLG leg and wheels did not show appreciable damage.

There was a wood pole close to the corner of the perimeter fence. The pole did not have any power line attached, but it had a metal strut wire attached to the ground. It seemed this wire helped stop the aircraft during the final impact.

The most important damage had occurred to the upper part of the fuselage due to the detachment of the wing, which rotated over its longitudinal axis initially clockwise when viewed from the left (i.e. leading edge up) and then anticlockwise (i.e. leading edge down). The first movement made the rear part of the nacelles to be crushed by the terrain of the slope. The second movement made the propeller spinners to hit the ground, and produced the detachment of all the blades of both propellers. Three blades of the right propeller and four blades of the left propeller were found deeply buried in the terrain of the slope, in the second pair of furrows. The other blades were thrown to the left and to the right of the trajectory of the aircraft, and their final position could not be precisely determined because they were moved and grouped during the rescue activities. The experts of the manufacturer however considered that the wing detached the fuselage in a continuous 360° rotation movement since the beginning in an anti-clockwise sense (i.e. leading edge downwards).

After the aircraft came to a stop, the wing remained leaning over the top of the fuselage, with its LH leading edge advanced 3.5 m and its RH leading edge moved forward 2.5 m with respect to their normal position. No liquid spillage marks were noticed on the right side of the fuselage. Some spillage of hydraulic fluid occurred on the left side of the fuselage, close to the position of trailing edge of the wing root. The right side of the fuselage showed wrinkles in the skin due to compression loads.

Major damage to some parts of the passenger cabin could be noticed, especially between seat rows 1 and 7. The floor was deformed and raised between rows 6 and 8, coincident with the part of the fuselage that ended in the open because the roof moved forward with the wing. Three overhead bins detached, two of them completely, and fell towards the seats (see Figure 1.15.1).

Door 1L was closed and could not be opened because the exterior handle was resting against the fence mesh. Doors 1R and 2R were open. Door 2L was closed and could be opened normally from inside and outside the aircraft.

The rest of the aircraft showed relatively minor damage. Most of the belly of the fuselage did not show many marks of dirt or grass, indicating that after the wing detached, the aircraft moved for a short distance leaning on its nose gear. This was coincident with the marks observed in the terrain (see 1.12.1). There was some grass and mud stuck to the tail bumper and to the air conditioning bay door.

Approximately 1,000 kg of fuel were unloaded from every half wing.

The cargo and luggage of the forward cargo bay were unloaded and weighed to a total of 240.5 kg.

The cargo and luggage of the aft cargo compartment was unloaded by emergency rescue people, without noting or measuring the weight. Statements gathered indicated

that there was «relatively low weight» in that compartment, maybe 120 kg total, with several bags and press packages.

1.12.3. *Status of the controls and indicators of the aircraft*

When the cockpit was inspected the day after the accident, the following information relevant to the accident could be obtained:

Both sliding windows were open and the rope of the FO was released outside the aircraft.

The two red alternate brakes levers were in their normal position (they are spring loaded, and therefore even after operation they return to their normal position).

Only one engine fire extinguisher bottle had been fired (left lever rotated to the right and right lever rotated to the left).

The fuel levers were positioned forward (open) and stuck. The torque indicators showed 20% for both engines. The LH power lever was slightly forward of flight idle. The RH power lever was slightly below of flight idle.

The altimeter was set at 1,020 mb.

The flap lever was at 35°, but the flap indicator showed 0°. The flaps were actually deployed to 35°.

The following circuit breakers were found tripped:

- LH Engine sig cond unit (13J) (Part 13, propeller).
- FLIGHT IDLE STOP SOLENOID 1 AND 2 (38J) (Part 38, engine).

The rear cone of the left engine nacelle was opened with great difficulty, because the rear part of the nacelle was heavily damaged, and it was found that the normal brake pressure indicator had 2,000 PSI and the alternate brake pressure indicator was showing 1,000 PSI.

The avionics panel (beside the 1R door) was opened and it was found that the skid control box had the indicators GND/FLT and 28V PWR showing failure (latched or «black and white»).

1.13. **Medical and pathological information**

There were 10 people injured as a result of the accident. They were taken to hospital in Melilla and released before 48 h.

Several toxicological analyses were performed for alcohol and abuse drugs on the pilot in command, copilot and flight observer, and the results were negative.

1.14. Fire

There was no fire. An airport fire-fighter noted that the aircraft overran and warned his colleagues at the same time when the alarm was activated from the control tower.

The fire-fighter brigade, composed by 5 men and two vehicles, went to the runway after asking the tower for authorization, reached the end of runway 15, and then the vehicles went back towards the perimeter road.

According to their report, when the fire-fighters reached the wreckage, they noticed that all the occupants had already left the aircraft (see paragraph 1.15.2). They saw a lot of smoke coming out the left engine and the left main landing gear, and they immediately applied two powder fire extinguisher bottles to those parts. Later on, they applied water with foam to refrigerate the area. A total of 600 l of foam and 2 powder fire extinguishers of 12 kg were used.

Shortly afterwards, fire-fighters from the city of Melilla arrived in the scene, and the airport brigade came back to their facilities to keep the airport operative.

Five airport fire-fighters that were on leave went to the airport to try to help when they learned about the accident.

1.15. Survival aspects

1.15.1. Cabin damage

According to the statements gathered, during the landing some occupants believed that touchdown was heavy and others thought it was normal. Some of them could notice that the aircraft was not decelerating normally. Later on, some passengers were not conscious of the aircraft having suffered major impacts until it jumped through the slope. Apparently there were no scenes of panic of the passengers until the aircraft came to a stop and the evacuation was initiated. All the occupants had their seat belts and harnesses (the flight and cabin crew) fastened, and no failure of any of those devices was reported.

As a result of the impacts when the aircraft jumped through the slope (the highest and latest recorded value of vertical acceleration was 5 g), the passenger cabin suffered important damage in its central part, where the wing was detached from the fuselage. The four seats of row 7 were detached and 2 overhead bins detached and fell towards the seats (see Figure 1.15.1). However, there was no noticeable damage to the seats, overhead bins or floor from row 8 towards the tail of the aircraft.

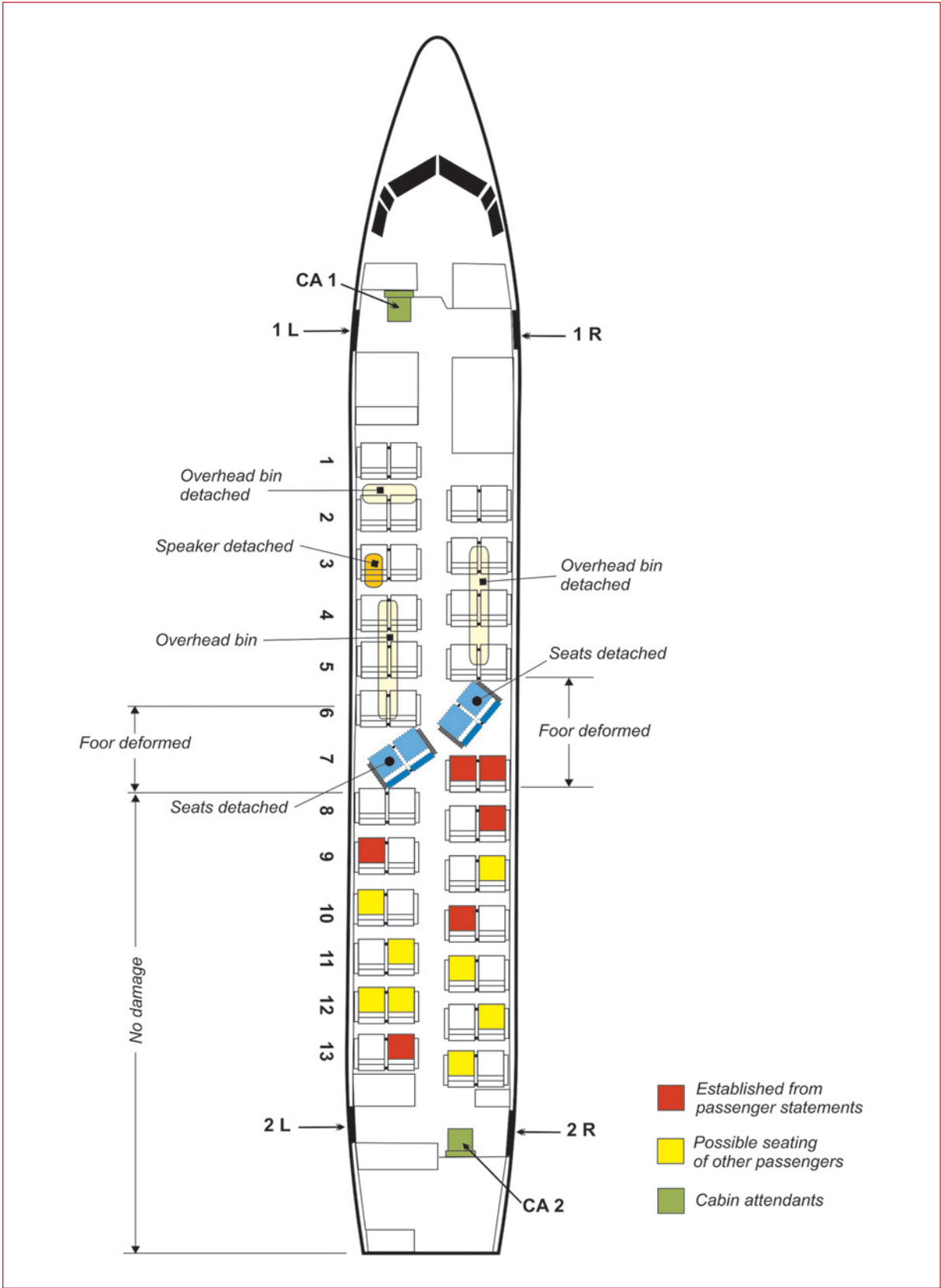

Figure 1.15.1. Drawing of the passenger cabin damage

Due to last minute cargo that was loaded on the aircraft, the pilot in command ordered that the passengers occupied the rearmost part of the cabin. It was not possible to determine exactly where every passenger was seated. When the passengers were interviewed, most of them did not recall exactly the seat they were seated in, except that they were generally «in the rear part of the aircraft».

However, according to the information gathered, the first row occupied by passengers during the flight was row 7 (seats 7D and 7F, on the right side). Other seats that were almost certainly occupied were 8F, 10C and 14C.

The seats in row 7 detached, but the detached overhead bins did not reach the occupied area. The passengers seated there only suffered minor injuries.

It seems that most of the vertical acceleration was initially absorbed by the landing gear and then by the breakage of the wing-fuselage fittings, which broke in plastic overload. The passengers noted how the sky was progressively appearing on the roof of the cabin during the fall of the aircraft through the slope.

1.15.2. Evacuation of the aircraft

The statements gathered indicate that after the aircraft came to a stop, the cabin attendant seated at the front of the cabin went to see the flight crew. The cabin attendant seated at the back waited some seconds for instructions.



Figure 1.15.2. View of the damage from the rear part of the cabin

The CA1 tried to open door 1L without success, since its exterior handle was trapped by the airport fence mesh. She also tried to open door 1R and noticed it was blocked. After other attempt, she could finally open it and left the aircraft through it. In the cockpit, both emergency windows were opened and the copilot evacuation rope released, although the flight crew left the aircraft through the doors.

In the meanwhile, door 2R had been opened without difficulties and most of the passengers and the CA2 left the aircraft through it. There was no intent to open door 2L, which was fully operative. At least two passengers left the aircraft climbing through the roof opening

The statements about the time that took the evacuation are variable. Some occupants said that evacuation was initiated around 20 s after the aircraft came to a stop. The fire-fighters stated that when they reached the scene, all the passengers had already left the aircraft wreckage.

At 11:01:26 h UTC (t) a security TV camera of the airport started recording. On this recording, it can be appreciated that approximately at $t + 2$ min and 9 s it seems all the passengers are outside the aeroplane. At $t + 6$ min and 20 s some airport fire-fighters can be seen on the recording. After 7 min 30 s of the start of recording, it can be seen that powder is applied to the aircraft. At $t + 7$ min and 40 s of recording time, the ambulance arrives in the scene. At $t + 10$ min 30 s the fire-fighters of the city of Melilla can be seen at the scene.

All the witnesses stated that the evacuation was quick and effective once the doors were opened.

1.16. Tests and research

1.16.1. *Testing of the flight idle solenoids on the field*

After the accident, with assistance of the manufacturer at the wreckage place, battery power was applied to the aircraft and the circuit breaker «FLIGHT IDLE STOP SOLENOID 1 AND 2» reset. In that condition, both left and right solenoids were energized and moved the stop levers. It was noticed that pulling the power levers in the cockpit against the stop levers prevented the solenoids from being able to remove the stop levers. This condition did not trip the circuit breaker, although it should be noted that the aircraft did not have full electrical power during that test.

The ground/flight (GND/FLT) microswitches of the left and right MLG appeared to work normally during the flight idle solenoid test.

1.16.2. *Bench testing of components of the propeller, landing gear and brake systems*

The main wreckage of the aircraft was transported to a hangar in Málaga and several components were removed from the aircraft to carry out detailed inspections and tests with the support of the aircraft manufacturer and vendors.

The relevant results are summarized below, with the important discrepancies highlighted to be discussed in other paragraphs.

Component	Relevant results
3LH Flight Idle Stop Solenoid - equipment n° L 2723A	No abnormalities noted in the tests carried out.
RH Flight Idle Stop Solenoid - equipment n° L 2723A	No abnormalities noted in the tests carried out.
Flight Idle Stop Solenoid 1&2 Circuit Breaker - equipment n° CB2997A	No abnormalities noted in the tests carried out.
Relay - equipment n° K 0887A	No abnormalities noted in the tests carried out. This is the «ground control relay» (see paragraph 1.6.3.1.2) and its operating time was measured to be 8.6 milliseconds and its release time was determined to be 16.4 s.
Relay - equipment n° K 2999A	The relay does not energize when electrical power is applied to contacts X1 and X2 and as a result the contacts do not switchover. The coil of the relay energizes when electrical power is applied to contacts X1 and D2. The coil resistance of the relay is 323,8 ohms. See discussion below.
Relay - equipment n° K 0262A	No abnormalities noted in the tests carried out.
Relay - equipment n° K 0253A	No abnormalities noted in the tests carried out.
RH MLG electrical harness	Based on the identification labels (attached during the removal of the harness) the wires to the LH and RH wheel speed sensors were interchanged. On the wiring no wire numbers or equipment numbers were present. The wire labelled as wheel n° 3 was longer than the wire labelled as wheel n° 4. See discussion below.
Parking brake micro switch box	Switches S2942A (2nd LH) and S1678A (1st LH) were physically interchanged. The break seal between the screw (for adjustment of the micro switch) and bracket assembly was broken. The correct wiring had been end-capped. Switch S1678A (1st LH) provided continuity at an angle of approximately +20 degrees (adjustment limit is +10 degrees). Switch S2041A (4th LH) provided infinity just above +10 degrees (adjustment limit is +10 degrees). No wire number identification was present on the wiring connected to the 3rd switch from the left. See discussion below.

Technical report A-002/2003

Component	Relevant results
Brake Units	<p>n° 1 S/N DEC86-0045 Wear indicator (with pressure) = 6 mm. Test results meet requirements shown in CMM. No abnormalities observed.</p> <p>n° 2 S/N APR91-0772 Wear indicator (with pressure) = 3 mm. Test results meet requirements shown in CMM. No abnormalities observed.</p> <p>n° 3 S/N APR87-0185 Wear indicator (with pressure) = 2 mm. Test results meet requirements shown in CMM. Unit had to be disassembled and no abnormalities observed.</p> <p>n° 4 S/N MAR87-0138 Wear indicator (with pressure) = 2.5 mm. Internal leakage shuttle-valve was detected. The shuttle-valve leaked one drop in 4 minutes and 50 seconds. Remainder of test results meets requirements shown in CMM.</p>
Dual Skid Control Valve LH - equipment n° B 0581A, P/N 6004122 MOD J, S/N DEC95-365	Valve passed functional test.
Dual Skid Control Valve RH - equipment n° B 0720A, P/N 6004122 MOD F, S/N SEP88-121	Valve failed the functional test. The pressure vs. current plots were out of tolerance. See discussion below.
Brake Control Valve LH	No abnormalities noted in the tests carried out.
Brake Control Valve RH	Leak-rate (internal) found too high with lever «full-on» 3.5 cc/min (allowed: 2 cc/min).
Parking Brake Shut-off Valve RH - equipment n° B 0575A	No abnormalities noted in the tests carried out.
Parking Brake Shut-off Valve LH - equipment n° B 0574A	No abnormalities noted in the tests carried out.
Shuttle Valve (wheel n° 3)	No abnormalities noted in the tests carried out.
Alternate Brake Control Valve RH	<p>The coupling nuts were torn off.</p> <p>During operation of the unit an unexpected tapping sound was heard. The unit has been opened and a black spot was observed on the piston, possibly causing the tapping sound.</p>
Alternate Brake Control Valve LH	The brake line was torn off.
Airspeed Indicator LH – equipment n° M 1464A	No abnormalities noted in the tests carried out.
Airspeed Indicator RH – equipment n° M 1465A	No abnormalities noted, with the exception that one light bulb was inoperative.
Airspeed Indicator Stand-by – equipment n° M 1501A	No abnormalities noted, with the exception that all light bulbs were inoperative.

Component	Relevant results
Antiskid control box P/N 6004125; S/N FEB89-0075	Some discrepancies noted in the functional tests. See discussion below.
Wheel speed sensor n° 1; P/N 6004123-1; S/N APR89-0388	Failed low speed output portion of functional test. See discussion below.
Wheel speed sensor n° 2; P/N 6004123-1; S/N APR89-0327	Passed functional test.
Wheel speed sensor n° 3; P/N 6004123-1; S/N N/A	Passed functional test.
Wheel speed sensor n° 4; P/N 6004123-1; S/N NOV89-0460	Passed functional test.

1.16.2.1. Possible effects of the discrepancies of the relay K 2999A

According to the specialists that carried out the tests, «The relay did not switch over when voltage was applied to the X1 and X2 connections of the relay. After 5 seconds (time delay on operate) the relay should have energized».

They also informed that "The amount of current drawn by the flight idle solenoid is highly dependent on the temperature. At room temperature the solenoids drew $2.36 + 2.3 = 4.66$ A. The circuit is protected by a 7.5 A circuit breaker. When looking at the tables [provided in their report] it can be concluded that the current may exceed 7.5 A at colder temperatures. The effect of failure of relay K 2999A is that the current will not be limited after 5 seconds. This means that the high currents as mentioned in the [tables attached to their report] will continue to run as long as the solenoids are energized. Since circuit breakers contain bi-metal devices to detect too high currents they require some time to heat up the bi-metal element before opening the electrical circuit [...]. This means that currents slightly in excess of the rating will not lead to immediate circuit breaker trips. Another effect that needs to be taken into account is the increase of temperature of the solenoids once power is applied. This effect will limit the current.

In view of the above it cannot be excluded that the circuit breaker tripped due to the relay K 2999A failure and subsequent high current.

However, in view of the circuit breaker characteristics (bi-metal requires some time to heat-up) it is unlikely that the circuit breakers tripped immediately after touchdown (the flight idle solenoids are energized when ground is sensed on one of the main landing gears or when wheel speed in and outboard is sensed on one of the main landing gears).

It is also possible that the circuit breaker tripped due to the g-forces during the impact on the slope or a shortcut during the wing detachment.»

Later on the manufacturer stated that «In the subject flight the lowest temperature to which the solenoids were subjected was about zero degrees C. This would have led to solenoid currents of at maximum 2,85 and 3,55 Ampere, respectively. Together this would be 6,40 Ampere which is well below the CB trip level of 7,50. Thus the theoretical possibility of CB tripping in colder circumstances is not relevant for the circumstances of this flight, especially if it is also considered that the warming up of the solenoids once powered will lower the initial currents of 2,85 and 3,55 Ampere». They considered it is a conservative approach to use zero degrees for the temperature of the solenoids taking into account the recording of the Total Air Temperature (TAT) from departure until the end of the accident flight and the corresponding estimate of the static air temperature. The temperature probe is located in the wing to fuselage fairing area. In the engine cowling confinement (where the flight idle stop solenoids are located) the temperature is known to be generally some 40-50 degrees higher than the static air temperature.

1.16.2.2. Possible effects of the discrepancies found on the parking brake micro switch box

The conclusion of the specialists was: «The Switch S2041A switched just above +10 degrees (at +10 degrees the switch must be closed). Switch S1678A switched at an angle of approximately +20 degrees (at +10 degrees the switch must be closed)».

«Review of the dimensions of the parking brake micro switch box and the travel of the actuation lever revealed that the mis-adjustment of the two switches would not have any operational effect.»

1.16.2.3. Possible effects of the discrepancies found on the anti-skid control box

The specialists of the vendor that carried out the tests stated that «The control box passed most of the individual functional tests. The discrepancies that were found were minor and can be corrected by normal recalibration. It is not unusual to find that control boxes require some recalibration after several years. The test limits are set to quite a close tolerance in order to allow some drift during service».

«Of the four individual antiskid channels, which control each of the four wheels independently, the Right Inboard channel is the most affected. The high modulator gain and low detector gain cancel each other out to some degree when summed together.»

«Although the box is not at optimum performance, the system will still function efficiently, especially on a dry runway.»

«None of the discrepancies would lead to a total malfunction either of the individual channel or the braking system as a whole.»

1.16.2.4. Possible effects of the discrepancies of the wheel speed sensor n° 1

This component senses the speed of the outboard left main landing gear wheel. A visual examination showed that the coupler was loose and semi-detached from the remainder of the unit. Damage was consistent with a significant impact to the coupler.

This sensor failed the low speed output portion of the functional test, because the ratio between the maximum and minimum output voltages at 200 rpm with a 10 K (10,000 ohm) resistance load was 1.29, while the maximum allowed was 1.20. However, the unit passed all the other test points.

The specialists that carried out the test considered that the discrepancy at the lower rpm setting was due to coupler damage, because at low rpm the drive did not rotate fast enough to keep the damaged coupler from a backlash condition.

1.16.2.5. Possible effects of the discrepancies of the dual skid control valve n° 2

This «dual» control valve located in the right main landing gear has two subassemblies, inboard (that controls pressure to wheel n° 3) and outboard (that controls pressure to wheel n° 4).

Both subassemblies or «control valves» were marginally out of the pressure/current plot tolerance envelope.

The out of tolerance condition of the wheel n° 4 valve would provide a higher pressure release for the same current with respect to an «in tolerance» valve.

The specialists of the vendor that carried out the tests also stated that the out of tolerance condition of the [wheel n° 3] valve would provide a proper skid control performance up to the point where the valve current/pressure trace exceeds the tolerance envelope, which happened in this case at 84% of the maximum current. This condition, together with a low runway friction coefficient (wet runway or lack of weight on wheels), could contribute to a flat spotted tire. High aircraft speed (at or near touchdown speed) and full brake application would also be required to contribute to tire damage.

It was pointed out that the mentioned performance anomalies are common in valves of this age, and that all other parameters of the functional tests were within acceptable limits.

1.16.2.6. Possible effects of the cross wiring of the RH MLG electrical harness

According to the specialists that carried out the tests, «The LH and RH connections were found interchanged. Measurements showed that the wiring labelled wheel n° 3 was connected to the RH wheel speed connection on connector P 1199B, and the wiring labelled wheel n° 4 was connected to the LH wheel speed connection on connector P 1199B».

«The wheel speed sensor cable conduit enters the MLG axle off centre (Right of the MLG axle centre). This means that the wiring to wheel n° 3 (the LH (inboard) wheel, of the RH MLG)) must be longer than the wiring to wheel n° 4 (the RH (outboard) wheel, of the RH MLG)). It was confirmed that the wiring labelled as wheel n° 3 was longer than the wire labelled as wheel n° 4.»

«This supports the conclusion that the outboard and the inboard wheel speed connections were interchanged.»

To be sure of the condition of the wiring at the moment of the accident, a more detailed study was carried out by the manufacturer of the aircraft under the supervision of the Dutch TSB. The conclusions of that study were:

1. The subject harness deviated from the drawing specification.
2. The length of the LH and RH wires were not in accordance with the specification of the installation drawing and SB procedures nor with the AMM procedures.
3. It is hardly impossible to remove (and install) the wheel speed sensor connectors when the wire labeled as n° 4 was installed in the axle of wheel n° 3, hence it is very unlikely that the wires had been installed in this way and thus very unlikely that they were labeled incorrectly.
4. Based on the wire identification (labels) and the results of the resistance check, the electrical connection of the LH and RH wheel speed sensors were interchanged.

In the opinion of the manufacturer of the aircraft, «The effect of wheels speed sensor cross connection would be that the skid control function will be lost. If for example the inboard wheel would skid then the skid control unit will generate a dump command to the outboard skid control valve. This means that the inboard wheel will remain to skid while the brake pressure to the outboard wheel will continue to dump. This will continue as long as the brakes are applied (assuming the inboard wheel remains skidding)».

1.16.3. *Estimate of the performances of the aircraft*

The aircraft AFM, Section 6.06.02, version 1, Issue 004, states that the Required Landing Field Length for a landing weight of 17,800 kg and 35° of flaps is 1,030 m when the threshold is crossed at 50 ft above the runway and with 1.3 Vs (approximately 95 kt) in wind calm conditions. The actual landing distance is 618 m, because a safety factor of 60% is applied. The actual landing distance is the distance necessary to come to a complete stop from a point 50 ft above the landing surface on a level, smooth, dry, hard surfaced runway at standard temperature with antiskid operative and without using propeller reverse (which must be regarded as an additional safety means). This value is then divided by 0.6 to obtain the Required Landing Field Length of 1,030 m.

The manufacturer was asked to inform about the landing distance required when the aircraft had the propellers at flight idle during the landing roll.

They answered that at 20,000 kg of landing weight and with 35° of flaps the flight test landing distance for AFM purposes (with 1 engine inoperative and feathered and the other engine in ground idle) was 686 m. In the case of having the engines in flight idle, that distance would be 721 m. The figure that appears in the AFM is 1,143 m (i.e., 686 m divided by 0.6). At 15,000 kg these figures would be 549 m, 616 m, and 915, respectively. The effect of having the engines in flight idle would be somewhat similar to having around 2,000 kg less of weight on wheels, due to the lift produced by the slipstream of the propellers.

The manufacturer added that the required landing distance increased rapidly with touchdown speed. For a landing weight of 17,758 kg and a touchdown speed of 89 kt the required «ground» distance with engines in flight idle would be around 450 m. However, a touchdown speed of 100 kt would require around 750 m of ground roll.

The manufacturer also informed that a landing with a wheel locked would lead to a tire failure shortly after touchdown, and would impose the full load of that side of the gear to be carried by the other wheel. If the brake torque is not the limiting factor, that wheel could at least theoretically produce twice the normal braking force, and therefore there would be only a marginal effect on the landing distance. However, the pilot should apply over that pedal about twice the force applied to the other pedal, because otherwise the aircraft would tend to veer towards the side with both tires undamaged and the deceleration would be less.

1.17. Organizational and management information

1.17.1. Organization of Air Nostrum

Air Nostrum is an operator that carries out regional scheduled passenger flights between many pairs of cities in Spain, Southwest Europe and North Africa.

It has an important fleet that includes Fokker 50, Canadair Regional Jet, De Havilland Dash 8, and ATR 72 aircraft.

It was licensed under JAR-145 to carry out regular maintenance on Fokker 50 aircraft. Aircraft PH-FZE was wet leased to Air Nostrum by Denim Air. However, it was being maintained by Air Nostrum personnel at the time of the accident because of further arrangements between both companies.

1.17.2. Organization of Denim Air

Denim Air B.V. had an Air Operator Certificate (in accordance with JAR-OPS) last issued by the Civil Aviation Authority (CAA) of The Netherlands on 28 October 2002,

with specification for passengers and cargo operations on 7 DHC-8-315 and 9 Fokker 50 aircraft. The allowed areas of operation were Eastern and Western Europe and Morocco.

They also had a maintenance system approval statement for Dash 8 Q315 and Fokker 50 aircraft, issued by the CAA of The Netherlands.

It was formerly a part of the Air Nostrum group. Close relationship existed between the two companies.

At the time of the accident, several aircraft, including PH-FZE, were wet leased to Air Nostrum. However, the maintenance of those leased aircraft was carried out by Air Nostrum in their bases in Spain.

According to the information included in their Operations Manual (OM), Part A, 9 February 2001 that was found on board the aircraft after the accident, the Denim Air organization was in line with JAR-OPS. It included a Flight Safety Officer, a Flight Operations Manager, a Ground Operations Manager, a Training Manager, and a Maintenance Manager (see attached graph).

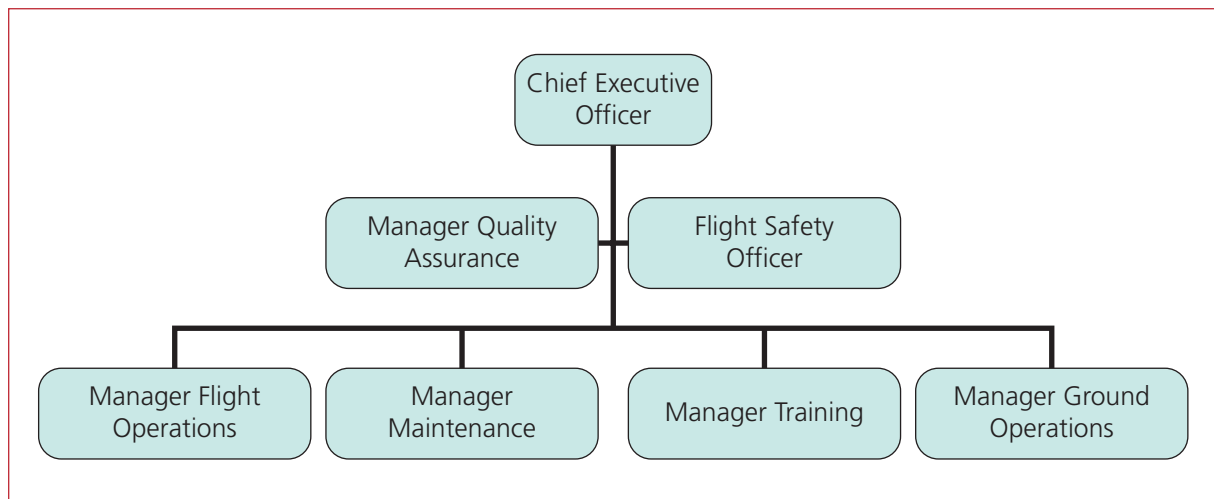

In the Operations Manual, the role of flight safety officer was defined and described. It was stated that: «The flight safety officer reports directly to the Accountable Manager, depending on subject(s) of the report». His responsibilities were:

- Carry out the tasks assigned by the Manager Flight Operations, or Manager Training.
- Report information relevant to the Flight Safety procedures to the Manager Flight Operations or the Manager Training.
- Coordinate activities with the Coordinator Cabin Crew Training.

His duties were:

- «— Establish and maintain a Flight Safety regime that meets or exceeds the legal requirements.
- Coordinate the Flight Safety efforts made for cockpit crew training and cabin crew training in general.
- Initiate programmes to achieve and maintain risk awareness by all persons involved in operations.
- Evaluate relevant information relating to accidents and incidents.
- Shall cooperate closely with the Manager Quality Assurance.»

1.17.2.1. Required crew qualifications and recent experience

It was not found in the OM any restriction regarding authority gradient or difference in experience between crew members.

1.17.2.1.1. *Pilot in command*

According to the OM of the company, the pilot in command was required to have completed at least three takeoffs and three landings as pilot flying, in an aeroplane or an approved flight simulator of the type to be used, in the preceding 90 days.

Additionally, since Melilla was classified as a B-airport (an airport that requires extra considerations as unusual characteristics or performance limitations) according to the OM (Section 8.1.2.5), a captain needed to be qualified for it after having thoroughly studied the briefing for that airport laid down in OM Part C.

1.17.2.1.2. *Copilot*

A co-pilot was required by Denim Air to have a JAA CPL license with at least 100 h of twin engine experience within Europe, and was not allowed to operate the flight controls during takeoff and landing unless he had operated as pilot flying during takeoff and landing of the type being used in the preceding 90 days.

Following the completion of flight training and checking as part of a conversion course, the co-pilots had to fly a minimum of 40 sectors under the supervision of a nominated captain, who was specifically trained.

There was no requirement for copilot qualification or minimum experience for flying to B-airports as Melilla or, in Melilla Airport itself, to fly to runway 15 that was considered the most difficult runway.

1.17.2.1.3. *Stabilized approach concept in the Denim Air Operations Manual*

In the OM, the Stabilized Approach concept (in the sense of Annex 6 and Document 8168 of ICAO) was not included. The only reference to approaches was found in the text on Section A-8, «Operating Procedures», page 66, where it was stated that «During all approaches the aeroplanes descent path must be carefully monitored. This is of particular relevance when conducting non-precision approaches where the altitude/height versus range/fix checks are to be strictly observed».

1.17.2.1.4. *Use of the GPWS*

The mentioned OM, Section A-8, page 47, 9 February 2001, included some information regarding the use of the GPWS. It was stated that «Whenever a [GPWS] warning is received, however, the immediate response must be to level the wings and initiate a maximum gradient climb to the [minimum safe altitude] MSA for the sector being flown, except as in paragraph 8.3.5.1 below».

«Paragraph 8.3.5.1: Warnings - Discretionary action by the Captain. The response to a warning may be limited, only if:

- (a) The aeroplane is being operated by day in VMC conditions which enable it to remain 1 NM horizontally and 1,000 ft vertically from cloud, and in a flight visibility of at least 5 NM; and
- (b) It is immediately obvious to the captain that the aeroplane is in no danger in respect to its configuration, proximity to terrain or current flight manoeuvre.»

Mode 1 of the GPWS is «Excessive sink rate». Mode 2 is «Excessive terrain closure rate». Both modes are only given when the aircraft is below 2500 ft above the local terrain. Therefore, it is stated that «if no corrective action is taken, a maximum of some 20 sec will elapse between initial receipt of the alert/warning and contact with the ground, and this will be lessened if the rate of descent is excessive, or there is rising ground beneath the aeroplane».

The AOM prepared by the manufacturer, which was on board as a part of the OM of the operator, states in section 7.08.01 that if a ground proximity warning is received, immediate corrective action is required unless it is obvious that the warning can be neglected. In the event excessive sink rate is announced, «immediately alter the aircraft path sufficiently to stop the warning».

JAR-OPS 1.395 «Ground Proximity Detection» (Change 1, 1 March 1998) states «When undue proximity to the ground is detected by any crew member or by a ground proximity warning system, the captain or the pilot to whom the conduct of the flight has

been delegated shall ensure that corrective action is established immediately to establish safe flight conditions».

1.18. Additional information

1.18.1. *Stabilized approach concept*

Annex 6 of ICAO «Aircraft Operations», Part I, Appendix 2, «Operations Manual Content» states that such a manual should contain at least the following:

- 5.18 Stabilized approach procedure.
- 5.19 Limits of descent speed when approaching the ground.

In ICAO Document 8168, Aircraft Operation, Volume I, Part IX, Chapter 3, some guidance is provided for this stabilized approach procedure. It should include the parameters for a stabilized approach, and provide data at least regarding the following factors:

- Speed range of every kind of aircraft.
- Minimum power rate of every kind of aircraft.
- Pitch range of every kind of aircraft.
- Tolerances of the deviation of the altitude.
- Configurations of every kind of aircraft.
- Maximum descent speed.
- Completion of checklists and crew briefings.

In general, all the flights should be stabilized according to the previous parameters defined by the operator at a height not less than 500 ft above the threshold of the runway (1,000 ft for flight in instrument meteorological conditions).

According to this ICAO document, the standard operational procedures of the operator should include the policy of going around in the event the approach is not stabilized with the above mentioned parameters or if it becomes destabilized at any point. This policy and the corresponding procedure should be highlighted with crew training.

Several operators have included this concept in their operations manual, using the recommendations of the corresponding ICAO working group. It is normally stated that the stabilized approach requires a constant glide path angle and a constant descent rate up to touchdown. Only small changes of heading and pitch are required to maintain the approach path. The engine power is stabilized and the aircraft trimmed to maintain the required speed in the desired glide path.

An extended practice within the industry is to consider that the following parameters must not be exceeded at 500 ft above the threshold (in VMC conditions):

- Approach speed between V_{ref} and $V_{ref} + 15$ kt.
- Vertical speed below 1,000 ft/min.
- Pitch angle in accordance with the standard operating procedures.
- Bank angle below 7° .
- Ground speed below $V_{ref} - 5$ kt.

If any of these parameters is exceeded, a callout by the pilot monitoring (PNF) to the pilot flying is required.

The following table gives the necessary descent rates (in ft/min) to keep a given glide path angle depending on the airspeed of the aeroplane.

Airspeed (kt)	Glide path angle (degrees)					
	$V_{ref} \pm$ wind	2.5°	2.75°	3°	3.25°	3.5°
90		395	435	475	525	560
100		440	485	530	580	620
110		485	535	585	635	680
120		530	585	640	690	745
130		575	635	690	750	805

1.18.2. *Landing distance requirements*

The landing distance is the horizontal distance used by an aeroplane from 50 ft of height over the runway at V_{ref} ($1.3 V_s$) to come to a complete stop, using normal braking means or by other means that can be used safely without special ability. This distance did not include, in the case of the aircraft involved in this accident, the use of the propeller reverse thrust.

The approach must be carried out at a speed not less than $1.3 V_s$ (stall speed). This speed is called the reference speed (95 kt the day of the accident of PH-FZE).

The joint operational requirements, JAR-OPS paragraph 1.515 "Landing - Dry runways" states that the operator should guarantee that a turboprop aircraft at the calculated landing weight can come to a complete stop from 50 ft of height over the runway within the 70% of the available landing distance of the runway used. The certification of the Fokker 50 AFM required field length is based on a more conservative figure of 60% as mentioned in 1.16.3.

Since the available landing distance of Runway 15 of Melilla was 1082 m (from a threshold to the other), the maximum distance available to come to a stop from 50 ft for any turboprop aircraft model or weight would be 757 m (70%), and 324 m (30%) would be the safety margin provided by the regulations.

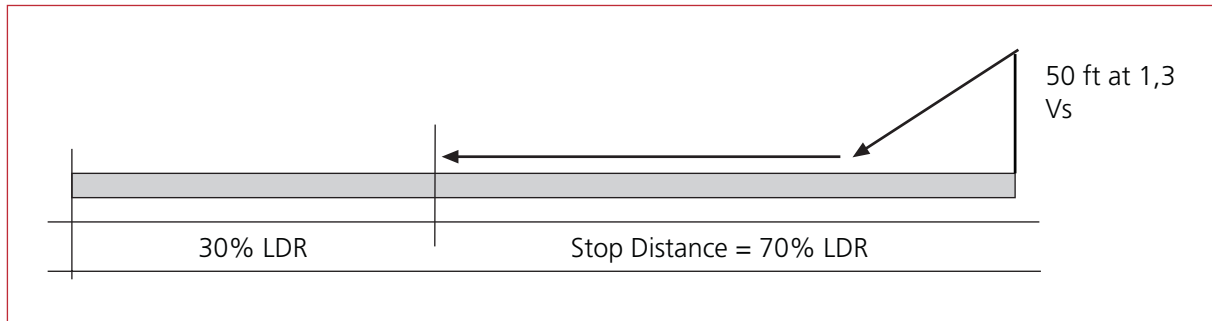

Minimum runway landing distance required (LDR) JAR 1.515 (turboprop)

1.18.3. *Instructions provided by the operator for landings at Melilla*

The OM, Part C «Route and Aerodrome Information» (23 September 2002) issued by the operator includes a briefing for Melilla Airport. The briefing is quite complete and it is stated that runway 33 is the preferred for landing. When landing on runway 15, «great care should be taken», and the use of «flap 15°» (should be understood as flap 25°) is permitted, but consideration should be given to the use of flap 35°.

The «Performance Guide Fokker 50», which is another part of the Operations Manual, gives some performance guidance to the pilots for landing at certain airports. It is stated that «pilot techniques have a major impact on the landing distance». As an example, a 10% increase in touchdown speed causes a 20% increase in the landing roll [distance]. The guide says: «Where possible, use the longest runway available, which will provide an added margin of safety».

The calculations for the required landing distances do not take credit for reverse thrust, except when landing in slippery runways.

The guide provides maximum weight for landing field length using 70% of landing distance available (LDA). On runway 15, with wind calm or up to 20 kt of headwind conditions, both with 25° and 35° of flaps, the maximum landing weight is 19,730 kg (anti-skid always operative). This is also the weight upper limit for landings at runway 33 under the same conditions.

However, if the braking coefficient is 0.40 or lower, this weight is reduced for runway 15, whereas for runway 33 the weight limit does not change for braking coefficients of 0.40, 0.35, and 0.30. As an example, with flaps 25° and braking coefficient of 0.40, the weight limit on runway 15 is 17,662 kg.

1.18.4. *Maintenance safety actions carried out by the operator of the aircraft*

After it was found that the wheel speed transducers of the RH leg of the MLG could have been cross wired, the operator carried out an inspection of the other Fokker 50

on their fleet to be sure that those transducers were correctly wired. The result of the inspection was that all the wiring was correct.

1.18.5. Operational safety actions carried out by the operator of the aircraft

On 22-1-2003 the Operator issued a «Daily Operational Bulletin» (Mess. Code GE-28-170103) to review existing procedures «to enlarge operational safety margins beyond those required by existing legal standards». Those measures did not imply any direct relationship to the cause of the accident of PH-FZE. The Bulletin included the four parts that are summarized below:

1.18.5.1. Airport briefing

It is reminded that Melilla was classified as a B-airport and every crewmember is obliged to review the briefing of the OM prior to his departure to MLN. The preferred runway is 33, in particular with a landing mass considerable less than the Performance Limited Landing Mass. Performance aspects shall be leading regarding runway choice, and any economical or passenger comfort aspect shall be ignored in the decision. As mentioned in Section 1.17.2.1.2 above, there were no requirements of experience of the copilot for landings in either runway of Melilla Airport.

1.18.5.2. Tail wind tables

It is advised that no tail wind landing on runway 15 of MLN is approved. No dispatch to MLN with antiskid inoperative or landing with antiskid inoperative on any runway of MLN is authorized.

1.18.5.3. Flight techniques

It is advised that the sloping terrain in the vicinity of Melilla could lead to an unstable approach. The approach policies of the OM are mentioned, as well as the landing techniques to maintain sufficient margin when landing on critical runways.

1.18.5.4. Non-normal and emergency conditions

If there is a failure of ground idle selection after landing, the provisions of the corresponding procedure of the AFM must be followed during landing roll (see paragraph 1.6.4.2).

If there is a failure of automatic flight idle stop, reference to OM B 3.17 «Bulletin 38» shall be made.

It is also stated that «If normal braking is experienced to be less than anticipated and the remaining runway length is critical, the use of Alternate brakes shall be considered. Beware that skid control is not available».

1.19. Useful or effective investigation techniques

None.

2. ANALYSIS

2.1. General

The aircraft was prepared to fly from Malaga to Melilla in a normal way in the morning of 17 January 2003. The aircraft had completed a lot of flights to and from Melilla without any major problem during the last months.

The crew was well rested and fit for the flight. According to the statements, nothing abnormal was noticed during the pre-flight inspections. Because the pilot in command saw that last minute cargo was being loaded in the forward cargo bay, he ordered that the passengers moved towards the rear part of the cabin. If the load sheets of the aircraft have been correctly interpreted (see paragraph 1.16.6), what happened was that from the initial 339 kg scheduled to be carried out in the rear cargo bay, 153 kg were finally not on board, and the actual weight in that compartment was 174 kg. The cargo in the forward cargo bay was the same as previously scheduled, 218 kg, except for the two bags (17 kg) of the cabin attendants that were finally put there. In any case, the weight and the cg of the aircraft were well within approved limits and, moreover, it could be argued that the aircraft was light to favour a landing in a runway as short as that of Melilla Airport.

The change of passenger position ordered by the pilot in command resulted to be the most fortunate decision to be taken because, in view of the damage suffered by the cabin, the potential personal injuries produced during the accident could certainly have been catastrophic.

There was a third pilot acting as an observer in the cockpit, which was a normal practice in the operator to help recently type rated pilots to gain experience with the operation of the aircraft. The pilot in command was providing him and the first officer with a lot of information during the cruise and descent phases of the flight, and the conversations in the cockpit allow to confirm that the captain, in addition to having a lot of flight experience with the Fokker 50, was also very familiar with the route to Melilla and the airport itself. The difference of experience between the captain and the other two pilots was overwhelming (12,900 h of the captain versus 457 h of the copilot and 250 h of the third pilot; the copilot had obtained his type rating only 4 days ago, and this was his third trip to Melilla and his first landing on runway 15).

The change from runway 33 to runway 15 at Melilla, due to the request of another company flight, was the first disturbing factor to flight ANS-8276.

According to the information gathered, the probable reason for this request was to avoid having to taxi back the runway to reach the apron, which happens if a landing is made on runway 33. If the landing takes place on runway 15, there is a possibility to

directly use the only available exit if speed has decreased enough. Otherwise, the end of the runway must be reached to turn the aircraft using the manoeuvring area. With this practice, it was probably intended to save some turnaround time.

The air traffic controller said that in such case both aircraft must use runway 15 and asked PH-FZE whether they accepted that runway. The controller did not express any preference or advised the use of any runway. He only informed PH-FZE of the request of the other company flight. According to the information gathered, the controller considered that the runway to be used was the decision of the pilots in command of both aircraft under those circumstances.

However, since the discussion about the runway was not picked up by the crew of PH-FZE at a first moment, because they were discussing other issues in the cockpit at that time, it took a while for them to assess the new situation, leaving less time to adapt the configuration and position of the aircraft to the new runway to be used.

In any case, the pilot in command of PH-FZE did not see any problem to use runway 15 but changing the previous schedule to 35° of flaps and 95 kt of reference speed. However, he decided to check the wind on final. He had previously stated that if the wind was 260/7 they would land on runway 15 but, if it was a little bit stronger, they would go around.

The result of the change was a very unstable approach and a high touchdown speed. However, it seems that those factors should not have prevented a successful landing even in the short runway of Melilla should all the braking and reverse means have been available, although with very little runway remaining after bringing the aircraft to a stop, due to the high final approach speed, aircraft flotation, etc. The pilot in command stated that he felt the approach and the touchdown point were normal, although the conditions were bumpy.

After the touchdown, the propeller ground idle/reverse could not be engaged and there was a braking system malfunction that eventually produced the lack of braking performance and the veering of the aircraft to the left until it exited the paved surface of the runway.

The information provided in Part I of this report does not allow to quickly identifying a single factor as the main contributor to the accident. It seems that the chain of factors that normally lead to an air accident and its consequences was even more noticeable in this case.

The following paragraphs try to analyse the complex mechanical causes of the accident and the operational factors that triggered those or that could have acted as contributors. The last paragraph tries to cover the crashworthiness and survival aspects of the event.

2.2. Aircraft systems malfunctions during the landing roll

Two different circumstances seem to have affected the decelerating capability of the aircraft: impossibility to select propeller ground idle/reverse after touchdown, and malfunctioning of the brake system that led to a poor braking performance and the deflation of tire n° 3 due to a flat spot.

The dry runway landing distance data of the AFM do not take credit of the propeller reverse capability. Therefore, with a normal touchdown speed and using only brakes (antiskid always operative), the aircraft should have been able to come to a stop within the 1,082 m of landing distance available in runway 15, from the point it was 50 ft above the threshold to the end of that runway, because it was almost 2,000 kg lighter than the weight limit to land in that runway in wind calm or headwind conditions (see paragraph 1.18.1). As this calculation was «Landing field length using 70% of LDA», it even provided for a 30% of safety margin distance for operational variations like different touchdown speeds, lower brake coefficient, delay to apply brakes, etc.

Therefore, the first and important factor affecting the braking capability of the aircraft was the status of the antiskid system, because the landing in runway 15 of Melilla was not allowed without antiskid except in the event of high headwinds. According to the statements gathered, there was no indication or warning of antiskid system malfunction before the touchdown, but it seems highly probable that the system did not work properly after that touchdown.

As a summary, even on the short runway of Melilla, the safety margins allowed for some kind of single failure, for example antiskid malfunction (that would be compensated by propeller reverse deceleration capability) or impossibility to select reverse thrust after touchdown (that was not accounted for anyway).

However, the simultaneous occurrence of both circumstances during the same landing, in addition to the high approach speed, exceeded the safety margins and eventually produced the accident.

The probability of both circumstances happening at the same time should be very low. It is considered that the reliability of both systems (brake and propeller reverse) should make that combination of failures extremely improbable, at least lower than 1 time per one thousand of million of flight hours (10^{-9}). The certification requirements of Federal Aviation Requirements (FAR) Part 25 establish that if antiskid devices are installed, the devices and associated systems must be designed so that no single probable malfunction will result in a hazardous loss of braking ability or directional control of the airplane. The term «probable» means a probability greater than 10^{-5} .

The following subparagraphs analyse the possible influence of every factor.

2.2.1. *Malfunctions in the braking system*

In the present accident, the following abnormalities of the braking system seem to have coincided during an undetermined period of time:

1. Crosswiring of the wheel speed sensors harness of wheels 3 and 4, which seems to have been in place and remained undetected since 19-6-2002 up to 17-1-2003 (see 1.6.5).
2. Performance outside the specification of the dual skid control valve of the RH MLG in some circumstances. The vendor informed that this performance is normal in valves of such an age, and therefore it remains unclear whether it should be considered a malfunction in the normal sense of the word.
3. Antiskid control box not at an optimum performance. The vendor informed that the discrepancies found were minor and could be corrected by normal recalibration, and that it was not unusual to find that control boxes require some recalibration after several years.

The cross wiring of the wheel speed sensors harness of the right MLG leg means that when wheel 4 is at high speed, the system receives the signal that it is wheel 3 the one at high speed, and therefore more braking pressure is applied to that wheel. Then, when the wheel 3 decreases its speed because of the higher pressure, the system thinks that it is wheel 4 the one that it is close to skidding and releases the corresponding braking pressure. Therefore, in a theoretical situation, wheel 3 would be receiving pressure all the time and wheel 4 would never receive pressure. To start the process it is necessary that there are differences of rotational speed or skid conditions between both wheels. This would result in a wheel 3 tire burst and, as a consequence, because wheel 4 was dumping, no RH braking at all.

According to the manufacturer, cross-connection of the wheel speed sensor harness has under normal conditions not important consequences because normally heavy braking is not used on the Fokker 50 (propeller ground idle/reverse is widely used to reduce braking needs) and near skid situations normally affect both wheels on one gear simultaneously. Therefore the system will not normally be requested to dump one wheel while allowing full brake pressure to the other and thus the failure can remain undetected for some time.

After an antiskid inboard channel failure noticed by a flight crew, the wheel speed sensor wire harness of wheels 3 and 4 was replaced on 17-6-2002 and, after some changes of the wheel speed sensors, another wire harness was installed on 19-6-2002 (see paragraph 1.6.5). After the changes of wire harnesses, in the Aircraft Maintenance Logs it was written «Test OK» and «Checked OK», respectively.

The aircraft had not complied with SB F50-32-024, issued to replace the wires that were routed to the wheel speed sensors inside the main landing gear legs (the wires were found broken in some instances) nor with SB F50-32-030, in which specific instructions

were given to check whether wires were crossed after compliance with SB F50-32-024. However, those instructions were introduced in the AMM, and were in force at the time of the accident in Melilla although in this case the cross wiring of the wire harness of the RH MLG was not detected.

The AMM states in the fault isolation section for wheels and brakes (task 32-40-00-811-851-A) that flat spots in one tire or one burst tire could lead to the conclusion, after a complex process of four steps of a fault isolation chart, that the «wiring of the wheel speed sensor is installed incorrectly - the outboard wiring to the inboard wheel speed sensor». Therefore, the identification of this fault by its effects on the aircraft was not immediate or obvious.

In the accident flight, it is possible that the lack of propeller reverse since the beginning of the landing roll prompted the crew to use heavier than normal braking, and for this reason this abnormal configuration that probably was hidden for months had noticeable effects on the aircraft.

When this fact was suspected during the investigation, the complete Fokker 50 fleet of the operator was checked and no additional cross wiring was found.

In view of all those circumstances, it is considered convenient to recommend the maintenance centre that carried out the wire harness replacement to assure that appropriate AMM check tasks are carried out and specifically recorded in the maintenance logs.

On the other hand, the RH dual skid control valve seemed to have been in service for around 14 years with no indications that it was overhauled during that period. It was stated that the out or tolerance condition found was common for valves of that age. Something similar applied to the antiskid control box, which was found with minor discrepancies that could be corrected with recalibration. It was also mentioned that it was not unusual to find that control boxes require some recalibration after several years. No requirement has been found in the maintenance documentation regarding overhaul periods for both components. The manufacturer stated that the present maintenance requirements standard for performance aspects on this type of equipment (skid control systems related) on aircraft of the same type generation as the Fokker 50 is condition monitoring, i.e. no scheduled maintenance, on the basis that deteriorated performance will manifest itself in service before hazardous effects can occur.

Although the specialists stated that the discrepancies of the RH dual skid control valve and the antiskid control box were minor, this applies to the isolated components. If such minor discrepancies are acting at the same time, they could theoretically under certain circumstances contribute to a major effect on the aircraft, as it could have happened in this accident. However, none of these circumstances could be identified in this accident, because the discrepancy on the RH dual skid control valve would have led to less brake pressure dumping in an impending skid on wheel 3 (if the sensor wiring would not have

been cross connected). In the accident it can therefore be considered irrelevant. Additionally, the discrepancies on the antiskid control box were marginal.

2.2.2. *Impossibility to select propeller reverse after touchdown*

It is highly probable that shortly after the touchdown the automatic flight idle stop solenoids of the propeller system did not retire the flight idle stops and therefore ground idle range could not be selected at the first intent. The pilot in command stated that he pushed a little bit forward the power levers and then tried again to move back the levers below flight idle, again without success. There is no information that he tried again later on during the rest of the landing roll. The «Flight idle solenoid 1 and 2» circuit breaker appeared tripped after the accident, and when the system was inspected after the accident, a failure of relay K 2999A was noted.

This relay lowers the current applied to the flight idle stop solenoids after 5 s to prevent them from becoming very hot. If the relay fails, a high current is continuously maintained. In a previous configuration not applicable to aircraft PH-FZE at the time of the accident (see 1.6.3.1.3) this would lead to tripping of the associated flight idle solenoid 1 and 2 circuit breaker (1 Ampere) in a few seconds. As indicated in 1.16.2.1, the 7.5 A trip level of the CB in the PH-FZE configuration would have been more difficult to be reached, but the continuous operation of the solenoids under those high currents could finally result in their failure and in the inability to select ground idle after landing, as it was stated by the manufacturer in their SED.76-12003.

However, the solenoids are only energized on ground when either enough wheel speed is sensed in both wheels of a gear leg or when the air/ground switch is in ground position. In the CVR, a positive sound of touchdown is heard at 11:00:37 h (DFDR time; the first signal of «ground» also appears on the DFDR at that moment). A second afterwards, the CVR recorded a sound believed to be the manipulation of the power levers with the intent of selecting reverse. At 11:00:42 h, and therefore 5 seconds after the touchdown sound, the pilot in command stated «I have no reverse».

All three crew members were quite sure that the aircraft did not bounce after the touchdown, which was termed as «positive». However, after the first «ground» sample, the logic changed to «air» for approximately 8 s and then was «ground» again until the moment the aircraft jumped through the slope. Finally, it is worth noting that in the previous two flights of the aircraft the air/ground switch seemed to work properly recording «ground» in the DFDR after the touchdown. Therefore, it is considered that a continuous failure of any component of this part of the air/ground logic, or of its recording to the DFDR, did not occur during the accident flight.

Taking into account the previous factors, it should be concluded that the lack of a recorded continuous activation of the ground signal after the first touchdown was due

to the fact that the shock absorber was not compressed enough to press the switch because the aircraft was floating with little weight on wheels, although without losing actual contact with the runway surface because a bounce was not noticed by the crew or recorded as a sound on the CVR and additionally no discontinuity of the runway marks was noticed after they appeared. That would mean that when the left MLG leg touched the runway surface, there was a shock absorber deflection of at least 38 mm, but afterwards, due to the relatively high touchdown speed that made necessary «to push» the aircraft onto the runway, there was enough lift to reduce that value of deflection of the shock absorber to the point the switch was deactivated for approximately 8 s.

If the aircraft had touched down with the circuit breaker in a normal position, the solenoids would have started to be energized either immediately, because there was a single sample of «ground» recorded in the DFDR or when the wheels started to spin up at around the same time. The maintenance documentation states that a signal of ground activates the «ground control relay» (measured to operate in 8.6 milliseconds after the accident) and this relay stays energized for 16 s and completes the activation cycle of the flight idle solenoids.

Under those conditions, when the pilot stated «I have no reverse», less than 5 s had elapsed since the touchdown, and it is considered unlikely that the circuit breaker had tripped in such a short period of time for which the solenoids were activated.

Therefore, it is considered more probable that the circuit breaker was already tripped at touchdown. It was considered possible that, when the landing gear was lowered in the approach to Melilla, the flight idle solenoids were activated in flight for 16 s as a result of a known failure condition of the systems associated to the antiskid control box modification status (see 1.6.3.1.3 with reference to Fokker 50 Service Letter 137). Normally this unintended in-flight activation of the solenoids would not have any consequence on the aircraft unless the pilot tried to move the power levers into the ground idle range. However, in this case, the failed relay K 2999A would have not lowered the electrical current to the solenoids after 5 seconds, producing a high electrical intensity to be present for the whole period of 16 s. Because aircraft PH-FZE had a 7.5 A circuit breaker protecting the solenoids circuits, the analysis of the manufacturer (see 1.16.2.1) considered very low the probability of this leading to the circuit breaker tripping. The process that led to the tripping of the circuit breaker could not be identified with a degree of certainty during the investigation, but this was a major contributor to the accident, and any step should be taken to correct known malfunctions of that system.

This circuit breaker is located in the rear part of the cockpit, behind the first officer seat. There was no requirement to check its status during the approach or landing phases, and therefore if the tripping had happened during any of those phases during the accident flight, the crew would not have noticed it.

The modification of the antiskid control box with the Aircraft Braking Systems Corporation (ABSC) Service Bulletin Fo50-32-24 would have eliminated the possibility of activation of the solenoids for 16 s after the lowering of the landing gear, but this bulletin was not mandatory and aircraft PH-FZE had not complied with it.

After the accident, the SB Fo50-32-38 was mandated by the CAA of The Netherlands with Airworthiness Directive 2003-091. This service bulletin requires, among other tasks, the modification to the antiskid control box as included in SB Fo50-32-24. Therefore, it is no longer needed to issue a possible safety recommendation in this regard. In addition to mandate the upgrade of antiskid control boxes, the airworthiness directive ordered other modifications related to identified malfunctions due to electromagnetic interference (EMI).

It was initially considered that the non-compliance of PH-FZE with Fokker Service Bulletin SBF50-76-013, which was not mandatory, increased the possibility of failure of the relay K 2999A and caused the tripping of the circuit breaker. However, as stated above, the analysis provided by the manufacturer considered very improbable this scenario.

In any case, some kind of unidentified circumstances happened that prevented the propeller reverse to be selected. Therefore, it is considered convenient to recommend that the safety analysis documentation of this system is reviewed to be sure that every possible mode of failure has adequately been identified and addressed.

It has been noticed that the antiskid control box is a common component of both the brake system and the propeller reverse system. It could contain potential modes of failure that could simultaneously affect both deceleration means, reducing the intended safety margins during landing rolls. However, none of those possible common modes of failure was identified during the investigation. Although no certification requirement has been identified to isolate the failure modes of both systems for landings in dry runways, because no credit is taken from the use of reverse in that case, this system is routinely used during landing rolls, when heavy braking is seldom required or used.

2.3. Operational aspects

The review of the available information shows that the operation was carried out in a normal manner during takeoff, climb and cruise phases. The pilot in command was providing a lot of information and advice to the other two pilots. The first factor that influenced the accident was the late decision to change the expected runway.

2.3.1. *Decision to change the landing runway*

During the approach and after the first contacts with Melilla tower, the crew was prepared to land on runway 33 as number 1. This meant that the airport circuit had to be

entered because that threshold was in the opposite side of the airport (see aircraft trajectory in Appendix A).

However, there was another company traffic, call sign ANS 8791, which was number 2 and wanted to use runway 15. In those conditions, the controller did not evaluate the position of number 1, but only proposed the pilot in command to use runway 15 too because it was needed that both aircraft used that runway. It could be argued that the position of PH-FZE was too high at that moment to try a straight forward approach to runway 15, but the controller considered this was the decision of the pilot in command.

The first mention to a possible change of runway was made at 10:54:35 h. However, it took like 105 sec (10:56:20 h) for the crew of PH-FZE to realize the situation, and then they had to make the decision in 6 sec and eventually accepted that runway. At that moment they were 12 miles out of the VOR, radial 330, with altitude 6,000 ft. This fact means that in less than 4 minutes they had to descend around 6,000 ft for the straight in approach. Therefore, the chances to land the aircraft after a normal, stabilized approach with that starting point were small.

However, it is possible that the pilot in command did not want to interfere in the operation of the other aircraft, which was also a company flight, and therefore was willing to complete the approach in that way. The captain was the PF at that moment, and therefore he had a high workload when had to make the decision to accept the new runway. The other two pilots did not question that decision at any time. The copilot was managing the communications and, after the captain made the decision, he informed the tower that they accepted runway 15.

The captain even discarded his previous plan («if wind is a little stronger [than 260 at 7 kt] then go around [i.e. land in runway 33]») and decided to land anyway with a wind noticeably stronger than that.

2.3.2. *Final approach and touchdown*

The aircraft was cleared to proceed to runway 15 at 10:56:13 h. A few seconds afterwards, the torque of the engines was reduced below 5%, which corresponds to flight idle. This throttle position was maintained until 11:00:08 h, at 457 ft of radio altitude, when some power was applied for 13 sec, and was reduced again to 5% when there were still 15 sec to touchdown.

To give an idea of the power management during the final descent, it may be pointed out that a typical value of the torque to keep 3° of glide path is between 15%-25%, and the final reduction to idle should happen 4 or 5 sec before touchdown.

During the descent, the aircraft was high and therefore some S-turns involving +26° and -29° of bank angle were carried out to lose altitude at around 10:58:45 h (DFDR time), and with an important variation of the vertical speed and the approach speed of the aircraft.

Four «SINK RATE» caution voices were generated by the GPWS with 1,480, 1,800, 2,280 and 2,100 ft/min. The last two cautions happened below 600 ft of height and the latest was heard in the cockpit at 11:00:12 h, when the aircraft was at 227 ft of height above the ground and with 128 kt of speed (the reference speed was 95 kt with 35° of flaps). The captain said «disregard» because he was aware that the warnings were being generated by the destabilized approach.

The operating procedures of the operator gave some flexibility to the captain regarding the response to a GPWS warning, but the procedures of the AOM of the manufacturer stated that in the event excessive sink rate was announced, «immediately alter the aircraft path sufficiently to stop the warning». In this case, the captain modified slightly the descent rate, but not enough to stop the warning.

In fact, at 500 ft above the ground, the aircraft was still destabilized, with 1,720 ft/min of descent speed, at Vref plus 20 kt, not at 3° of glide path, and with engines at idle. This compares with the stabilized approach policy of ICAO (below 1,000 ft/min, between Vref and Vref plus 15 kt, engines with power, etc.) to give the conclusion that a go around should have been initiated immediately. The following graph compares a standard approach with the approach conditions faced by aeroplane PH-FZE.

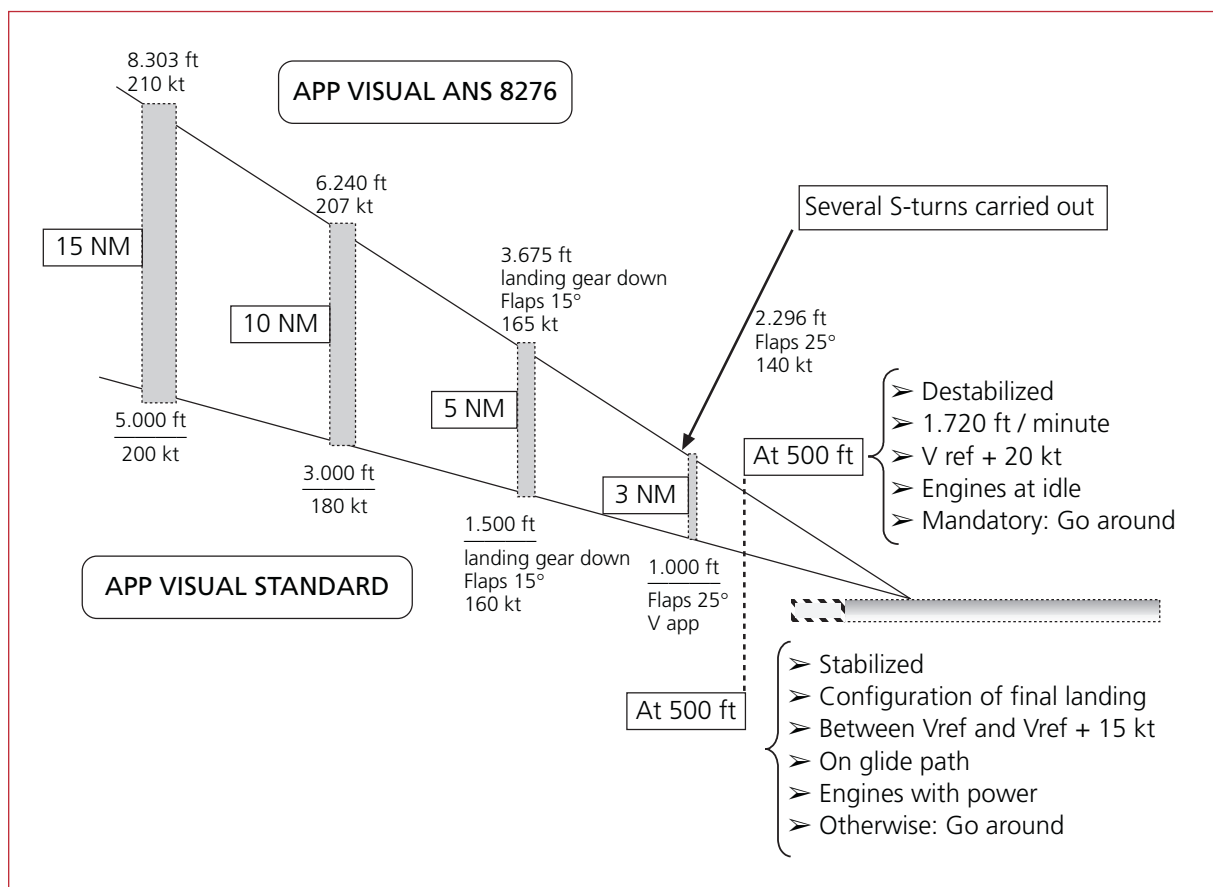

Twenty seconds before touchdown the speed was 147 kt (i.e. 52 kt above the maximum recommended touchdown of 95 kt).

However, the pilot in command continued the approach maybe in confidence that his large flying experience could make him to stabilize the aircraft before the touchdown.

For the analysis of this decision, it must be considered again that the captain probably did not want to alter the expected course of action of the other company flight that was behind him following and observing his approach. The copilot (acting as monitoring pilot) never made any callout of significant deviations of the flight parameters or questioned the suitability of the approach.

As already mentioned in section 2.1 above, there was a very pronounced authority gradient in the cockpit between the highly experienced captain and the copilot, who had obtained his type rating only 4 days before the accident, and had flown to Melilla only in other occasion when they landed in runway 33. The policy of the operator permitted a crew composition with such a big difference in experience, even for difficult runways as was the case of runway 15 at Melilla. As it had happened other times, it is quite possible that the copilot did not question the operation at any time because he thought that the captain was very knowledgeable with such kind of landings in Melilla. However, this behaviour could have resulted in the copilot not performing the monitoring tasks that should have carried out in accordance with his role of PNF.

The operator did not have a detailed procedure for stabilized approaches in their operations manual, but even with the general wording of the manual «During all approaches the aeroplanes descent path must be carefully monitored. This is of particular relevance when conducting non-precision approaches where the altitude/height versus range/fix checks are to be strictly observed» could be considered as having been largely exceeded in this case.

At 50 ft of height over the runway the speed was 118 kt. According to the statements gathered, the crew did not feel it was a very unusual or uncomfortable approach, although they acknowledged it was unstable, and they thought a normal, safe landing could be carried out without any hazard. The final part of the approach was very flat and there was virtually no flare, because the pilot had to fly the aircraft onto the runway applying forward control column and, when the aircraft entered the ground effect, it floated for a while. The touchdown was quite positive and the aircraft, as the crew recalled, did not bounce, although it is possible that there was little weight on wheels for approximately 8 s.

2.3.3. *Braking and propeller reverse application*

Shortly after touchdown (approximately 1 s after the sound of ground contact was recorded on the CVR), the pilot in command tried to select ground idle range to apply

propeller reverse power as soon as possible. Since it is probable that the shock absorber of the main landing gear was compressed enough only for a sample as recorded in the DFDR, the flight idle locks would only have retracted if the corresponding signal activated the ground control relay in a normal mode. Alternatively, the other circumstance (enough wheel speed up) would need to have been complied with. Whether the wheels had reached enough speed in around one second, with the little weight on wheels due to the high final approach speed, is uncertain, but not unlikely given the initial firm touchdown. The AFM states that reverse should not be applied before the nose wheel is on the ground. According to the DFDR data, it seems that this condition was complied with during the accident touchdown.

In view of this circumstance, it was initially considered possible that a too early attempt to select ground idle had pushed the power levers against the automatic flight idle locks, thereby preventing their retraction, and eventually had tripped the circuit breaker due to electrical overload. However, this possibility was considered improbable, because after that first attempt, the pilot, who had long experience on the aircraft, reported to have advanced the levers a little bit and tried again to select ground idle range, although this could not be completely confirmed by the CVR. Additionally, as previously discussed, at least a «ground» signal existed during touchdown, and it should have been enough to provide the conditions for complete solenoid activation once the ground control relay was first energized.

Statements gathered from experienced pilots indicated that the aircraft is difficult to land with such high touchdown speeds. Such circumstance would not have had noticeable influence with all the deceleration systems operative in a long runway. However, in the short landing distance available in runway 15 of Melilla, it further reduced the safety margins.

Since there appeared to have been a problem of high touchdown speed, consideration was given to the fact that there were several discrepancies noted between both main airspeed indicators (ASI) for several months (see paragraph 1.6.5), 8 kt being the maximum difference reported by flight crews.

While en route in the accident flight, the crew stated that there was a difference of 5 kt between ASI. The AMM of Fokker allows 5 kt as the maximum allowable difference between airspeed indicators. Even considering the possibility that the crew used on board an ASI that was indicating 5 kt below the actual airspeed, and therefore when the aircraft had 118 kt at 50 ft as recorded on the DFDR they thought they were at 113 kt, there was still an important increase over the expected Vref of 95 kt. The crew stated that they were aware that the approach speed was being high.

After the crew realized that ground idle/reverse could not be engaged, the pilot in command applied brakes and later on the copilot also pressed the brake pedals, but they did not notice a normal deceleration. It is possible that the heavier than normal brake appli-

cation made the several brake system latent malfunctions described above (especially the crosswiring of the n° 3 and 4 wheelspeed sensor wiring) to show their effects and to produce to tire 3 flat spot and the loss of braking capability of the RH MLG. This loss was considered by the manufacturer to be more that 50% of the braking capability of the aircraft.

Under those circumstances, it was considered whether the pilot in command should have applied the alternate brakes, for which there are two levers in the left part of the cockpit. Maybe if the right alternate brakes would have applied, and all the brake pressure would have reached the right wheels, the aircraft would not have deviated to the left. The pilot in command stated that he considered that this application would have quickly burst all the tires, making the directional control even worse. It seems that there was no specific guidance or training for the use of the alternate braking system. The manufacturer of the aircraft considered that the application of alternate brakes in other circumstances is generally left to basic airmanship considerations, as there are no clearly identifiable conditions in which this should be prescribed. They added that it would be questionable if some general remarks on the benefits of the alternate braking system in case of less than expected braking performance in an AOM system description would have helped the flight crew in this specific case. Moreover, as the pilot rightly assumed: it may be well the case that more often than not braking performance would turn out to be worse due to the loss of antiskid protection, especially since (with a correctly wired system) these situations almost always occur on runways with reduced runway friction.

However, in view of the fact that an experienced pilot did not use that system in this case (when the runway friction is normal) when the chain of circumstances happened in a rapid succession, it is still considered convenient to issue a safety recommendation to increase the training of flight crews to help them make quick decisions regarding application of alternate braking system in similar situations.

2.3.4. *Landing distance*

One of the effects of the destabilized approach was the need of more landing distance which, in the short runway of Melilla, had a significant importance. The following factors normally influence the required landing distance:

- a) High reference speed: Every knot above the required reference speed over the threshold may add 20 to 30 ft of actual landing distance. In this case, the speed at 50 ft was 118 kt, although the threshold was crossed at 15 ft (very flat final approach) with 115 kt of airspeed. This means 20 kt above the expected reference speed and around 400 ft-600 ft of distance penalty.
- b) High altitude over the threshold: Crossing the threshold at 100 ft instead of 50 ft could add around 950 ft to the required landing distance. In this case, the threshold was crossed at 15 ft of height, but then this fact probably imposed flare and flotation problems.

- c) Tailwind: 10 kt of tailwind could add around 800 ft of landing distance. In this case, although it is not possible to know exactly the wind component at the moment of touchdown (the controller had provided the value 240/12 kt varying between 210 and 300), it seems there was no significant tailwind component.
- d) Excess touchdown speed: The touchdown happened with between 107 kt and 98 kt, while the recommended touchdown speed was between 95 kt and 85 kt (it can be assumed that the touchdown happened with 10 kt of excess speed). Around 7 seconds of «air» signal were recorded after the first «ground» signal, meaning that there was less weight on wheels than expected. Even in a normal landing (without brake failure) this excess of speed would cause floating problems (i.e. less effective braking action) and a penalty estimated in around 20 ft per kt of excess. In this case, that factor could have added around 200 ft of additional distance.

In other words, assuming that there was no reverse available, which is not accounted for anyway in the dry runway landing distance requirements, even in the event the braking system would have been working normally, the aircraft would have needed:

618 m (normal landing roll distance) plus 244 m (those 244 m or 800 ft of penalty result from the 600 ft of high reference speed plus the 200 ft of floating due to high touchdown speed) to give a total of 862 m of actual penalized landing distance.

Therefore, the safety margin of 30% of LDR (265 m) provided over the actual distance would have been almost completely wasted because of the destabilized approach and the high reference and touchdown speeds.

The runway length was 1,082 m, and thus it still had 220 m of extra margin, but the brake failure was decisive in producing the runway overrun.

The analysis of the runway marks and the FDR-based trajectory gives the following conclusion (there are 54 m between threshold 33 and the point where the FDR stopped recording):

- a) The touchdown happened at 838 m from threshold 33 (i.e. at 244 m from threshold 15).
- b) The first braking marks were noted at 824 m from threshold 33 (i.e. at 258 m from threshold 15).

See Figure 1.11.2.3.1 and Appendix B to see drawings of those marks and trajectory.

2.4. Crashworthiness and survival aspects

As it has been discussed in several parts of this report, it was most fortunate that all the passengers were seating rearwards of seat row 6, and only minor injuries resulted

from this accident in which high loads were achieved by the aircraft structure and the complete wing assembly detached from its joint to the fuselage.

It seems all the passengers had their seat belts fastened, and items of mass that became loose within the cabin, specially the heavy overhead bins, did not seriously affect any aircraft occupant. Then the evacuation was carried out in an orderly manner while the fire fighters were trying to reach the wreckage. The arrival of the first fire fighting vehicle was delayed because they initially went to the end of runway 15. Since the vehicle could not descent through the steep embankment, it had to turn back and use the perimeter road of the airport while some fire fighters descended the slope by foot.

The available information suggests that the time used to completely evacuate the aircraft was within the value specified in the requirements.

The four wing-fuselage fittings broke after the main landing gear impacted into the ground after the aircraft jumped through the slope. This fact was also beneficial because it prevented the high accelerations achieved in that impact (a maximum of 5.8 g was recorded by the DFDR) from being transmitted to the passenger cabin and then to the occupants. That load exceeded the load requirements for the joint fittings, which were inspected after the accident without any pre-existing defect being obviously noticeable.

Once detached from the fuselage, the wing rotated around its longitudinal axis in a complex movement, because the rear part of the nacelles dug two furrows on the terrain, then no marks appeared for 3.8 m (RH nacelle) and 6.2 m (LH nacelle), and then other two furrows were dug by the front part of the nacelles. The propeller blades broke and detached in the middle of those burrows. Afterwards, the wing continued with the same horizontal speed as the fuselage until it came to a rest above the passenger cabin with some displacement and rotation with respect to its normal position.

The most important factor that affected the survival in the accident was, apart from the fact that the runway had only 1,082 m of landing distance available, the existence of a steep drop at the end of runway 15 that obviously posed a big hazard in the event of a runway overrun. In the other direction, runway 33 had 1347 m of landing distance available. The choice of the runway was left to the pilot in command in case both runways were available regarding prevailing wind conditions. The operator had instructions in place for their pilots indicating that runway 33 was preferred for landing at Melilla Airport whenever possible (Operations Manual, Part C, Section 7-24), while runway 15 was the preferred runway for takeoff. However, in this case a company flight requested runway 15, probably for turnaround time minimization, and the controller asked the crew of PH-FZE whether they could also use that runway.

The declared landing distance available of Melilla Airport for runway 15 (1,082 m) did not allow the existence of a length of 60 m of strip at the end of that runway, and

therefore did not comply with the recommendations of Annex 14 of ICAO. After the modification of the AIP of Melilla Airport in October 2003, the stopway at the end of runway 15 has been deleted but still only 33 m of runway strip are available, instead of the 60 m requested by ICAO. Additionally, the width of the strip is 80 m instead of 150 m as recommended in Annex 14. Therefore, it is considered convenient to recommend AENA to study a possible modification of the declared distances of Melilla Airport to bring them in line with the content of ICAO Annex 14 regarding runway strip dimensions.

It is difficult to envisage other safety measures that overcome the existence of the slope at the end of runway 15. The terrain beyond that slope is occupied by a road and then by buildings that are all well below the level of the runway, making any construction works to alleviate the problem very difficult and costly. There is little available space for airport enlargement in the city of Melilla, and therefore the primary preventive measures would be the already mentioned of providing a runway strip in line with that recommended by ICAO Annex 14, and strictly adhering to existing procedures to avoid reducing the safety margins in such a short runway.

3. CONCLUSIONS

3.1. Findings

- The aircraft had a valid Certificate of Airworthiness.
- The mass and centre of gravity of the aircraft were within the prescribed limits.
- The pilots had valid licenses and were adequately qualified for the flight.
- There was no evidence that incapacitation or physiological factors affected the flight crew performance.
- Toxicological tests carried out on the flight crew members after the accident were negative.
- The approach to runway 15 was very destabilized in airspeed, descent rate, glide path, and maximum roll angles.
- The reference speed for the approach to runway 15 of Melilla Airport was scheduled to be 95 kt. Twenty seconds before the touchdown the airspeed was 52 kt above the reference speed, and when the aircraft was at 50 ft of height above the ground its speed was approximately 118 kt (23 kt above reference speed).
- The aircraft touched down with a speed between 107 kt and 98 kt.
- After a signal of «ground» was recorded in the DFDR at approximately 11:00:37 h, a signal of «air» was recorded for the next 14 samples of the air/ground parameter.
- After touchdown, the pilot in command realised and stated that he could not engage the propeller reverse range.
- The pilot in command and the copilot stated that they applied brakes during the landing roll.
- The aircraft did not decelerate in a normal way. Only in a few samples recorded in the DFDR the horizontal deceleration was higher than 0.25 g.
- The tire of wheel n° 3 was blown.
- The left main landing gear leg of the aircraft left the paved area of runway 15 approximately at 110 m from the end of that runway.
- The aircraft fell through an embankment of around 15 m of height that is located at the end of runway 15. The horizontal aircraft speed at the time of falling through the embankment was approximately 48 kt.
- The wing-fuselage attachments broke when the aircraft contacted the ground in the embankment.
- The aircraft suffered a maximum vertical acceleration of 5.8 g after it jumped through the embankment at the end of runway 15.
- After the accident, the wiring harness of the wheel speed transducers of wheels 3 and 4 was found crosswired.
- The relay K 2999A was found after the accident to have a discrepancy because it did not switch over to reduce the current applied to the flight idle solenoids after 5 seconds.
- The circuit breakers «LH engine signal conditioning unit» and «Flight idle stop solenoid 1 and 2» were found tripped.

- The cause and the moment of the tripping of those circuit breakers could not be determined.
- The antiskid control box was found to have some minor discrepancies when tested after the accident.
- Runway 15 of Melilla Airport did not comply with the recommendations of Annex 13 of ICAO.

3.2. Causes

It is considered that the accident probably happened because of a combination of three factors:

1. An unstable approach that resulted in a higher than normal touchdown speed.
2. The inability to select propeller reverse due to the probable tripping of the circuit breaker «FLIGH IDLE SOLENOID 1 & 2» before or at touchdown.
3. The cross connection of the wheel speed transducer wire harness of wheels 3 and 4, which, due to heavy braking, produced a flat spot in wheel 3 and reduced the braking capability of wheel 4.

4. SAFETY RECOMMENDATIONS

After the accident, the operator took several safety actions as described in section 1.18.5 above. AENA informed that construction works were scheduled at Melilla Airport to try to comply with the requirements of Annex 14 of ICAO.

- REC 39/05.** It is recommended to Denim Air that the stabilized approach policy of ICAO is included in the operations manual, as well as more detailed procedures to respond to GPWS warnings. The need of the pilot in command to make a positive decision regarding a go around when the approach conditions have degraded, and the need of the pilot not flying to adequately monitor the flight and make the corresponding callouts when applicable, should be further emphasized during training.
- REC 40/05.** It is recommended to Air Nostrum that it is assured that relevant AMM check tasks are appropriately performed and specifically recorded in the maintenance logs.
- REC 41/05.** It is recommended to the Civil Aviation Authority of The Netherlands that a safety review is carried out on the propeller reverse selection system of the Fokker 50 aircraft to be sure that all possible failure modes that would prevent the selection of propeller reverse after touchdown have been adequately addressed.
- REC 42/05.** It is recommended to the manufacturer of the aircraft that specific training guidance is provided to operators regarding the use of the alternate braking system, to allow flight crews to make quick decisions regarding the feasibility of its use in emergency conditions.
- REC 43/05.** It is recommended to AENA to study a possible modification of the declared distances of Melilla Airport to bring them in line with the content of ICAO Annex 14 regarding runway strip dimensions.

APPENDICES

APPENDIX A
Diagram of the horizontal trajectory
of the aircraft

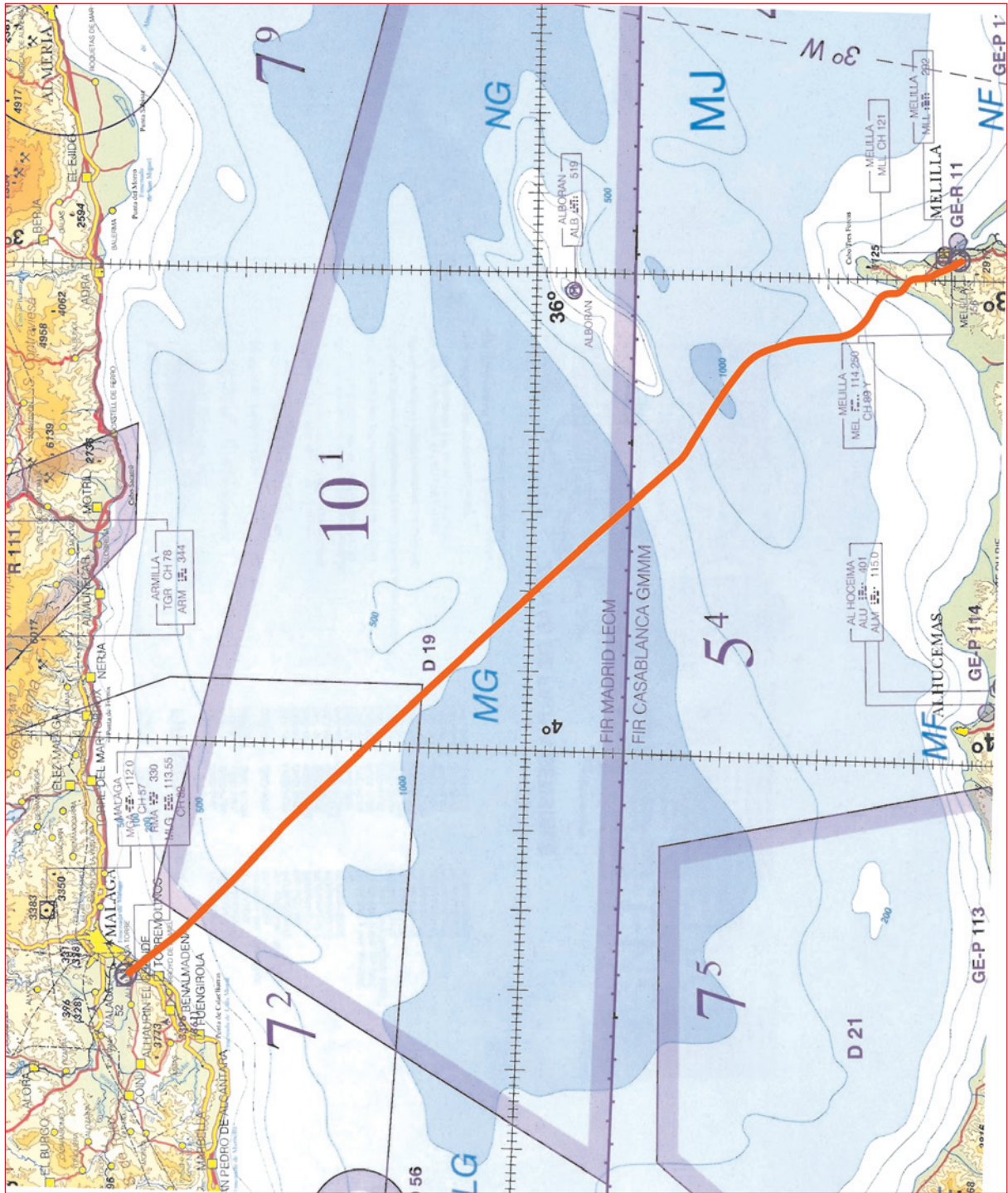

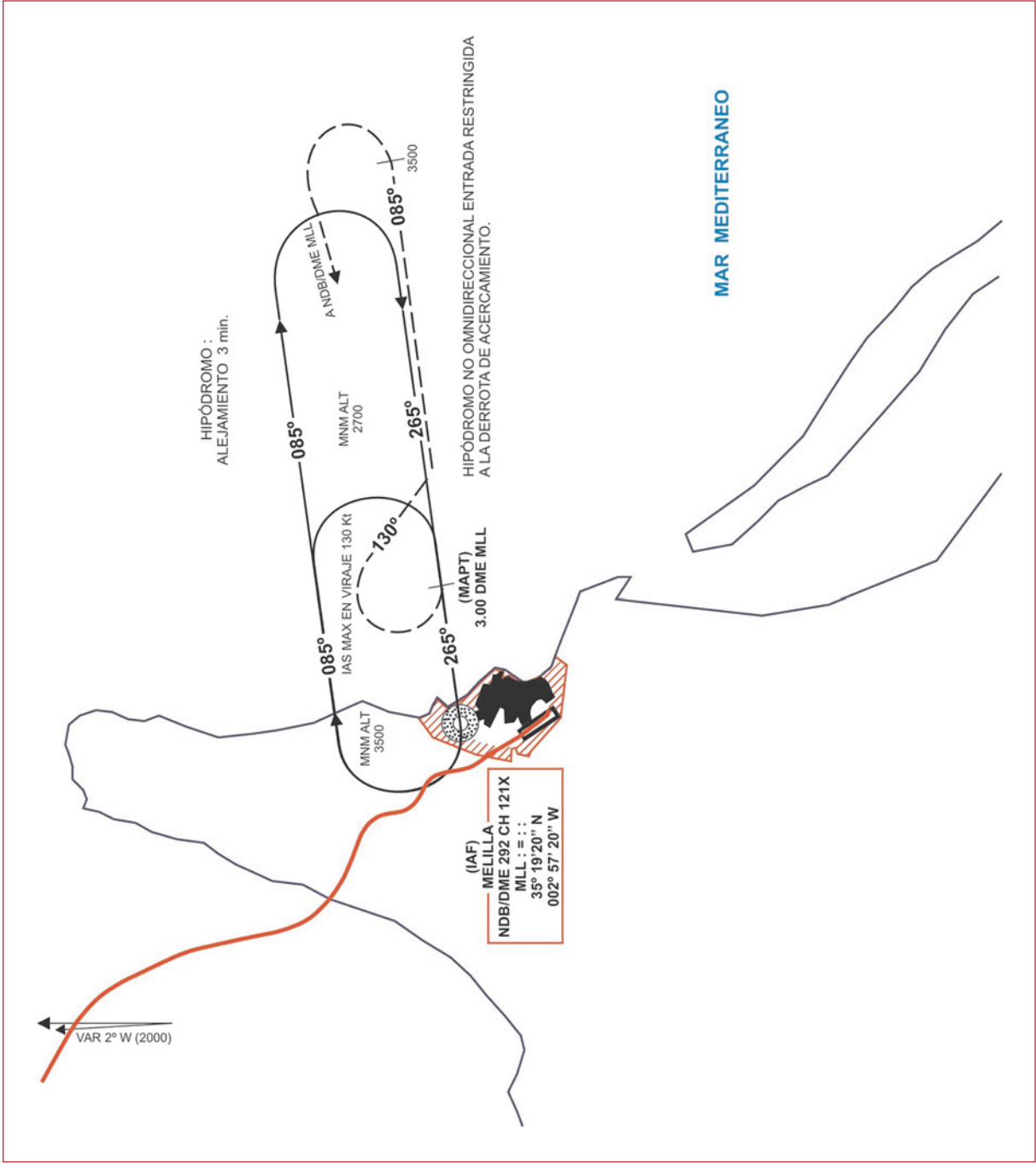

APPENDIX B
**Ground track of the aircraft
and marks on the terrain**

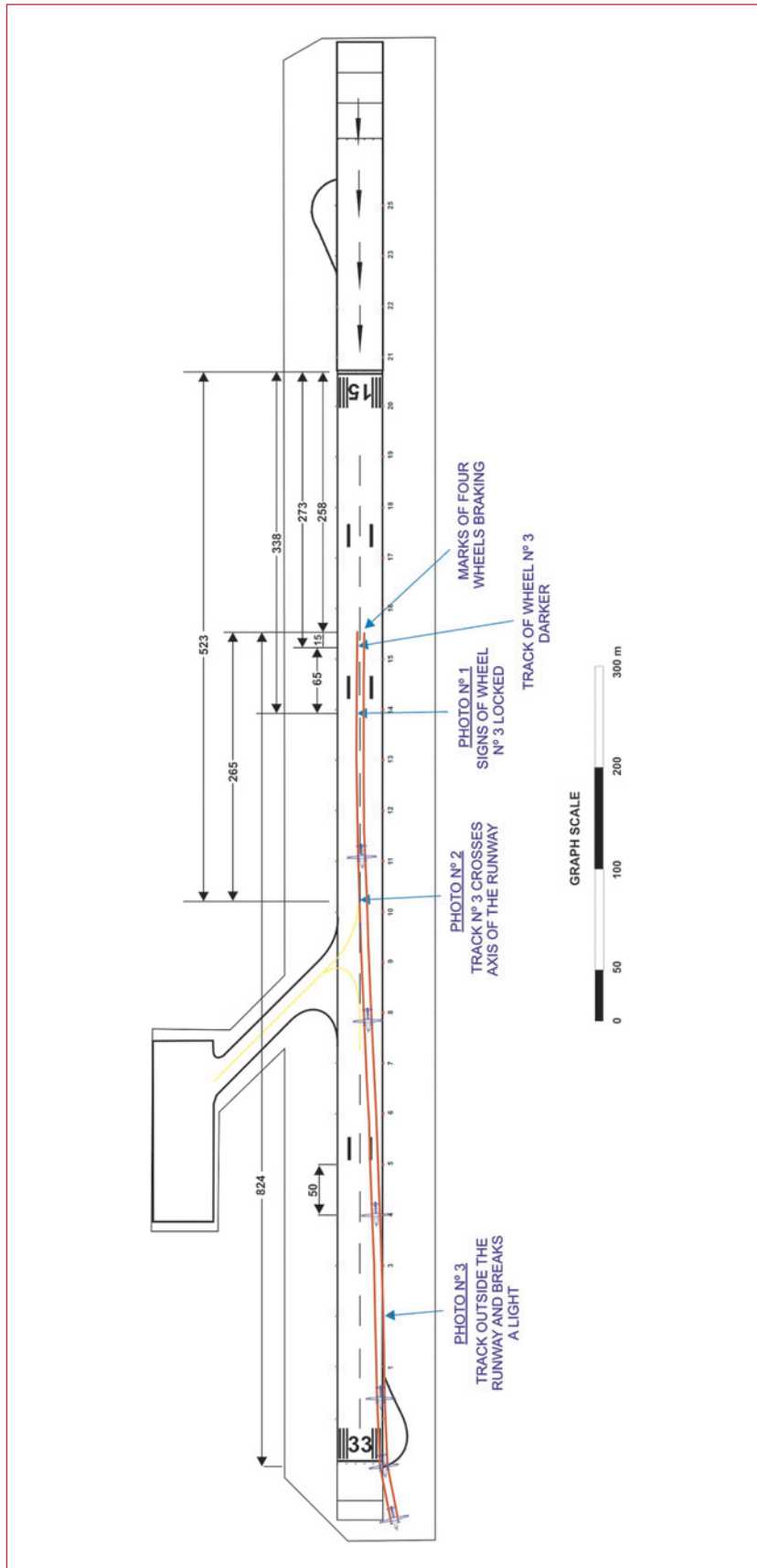

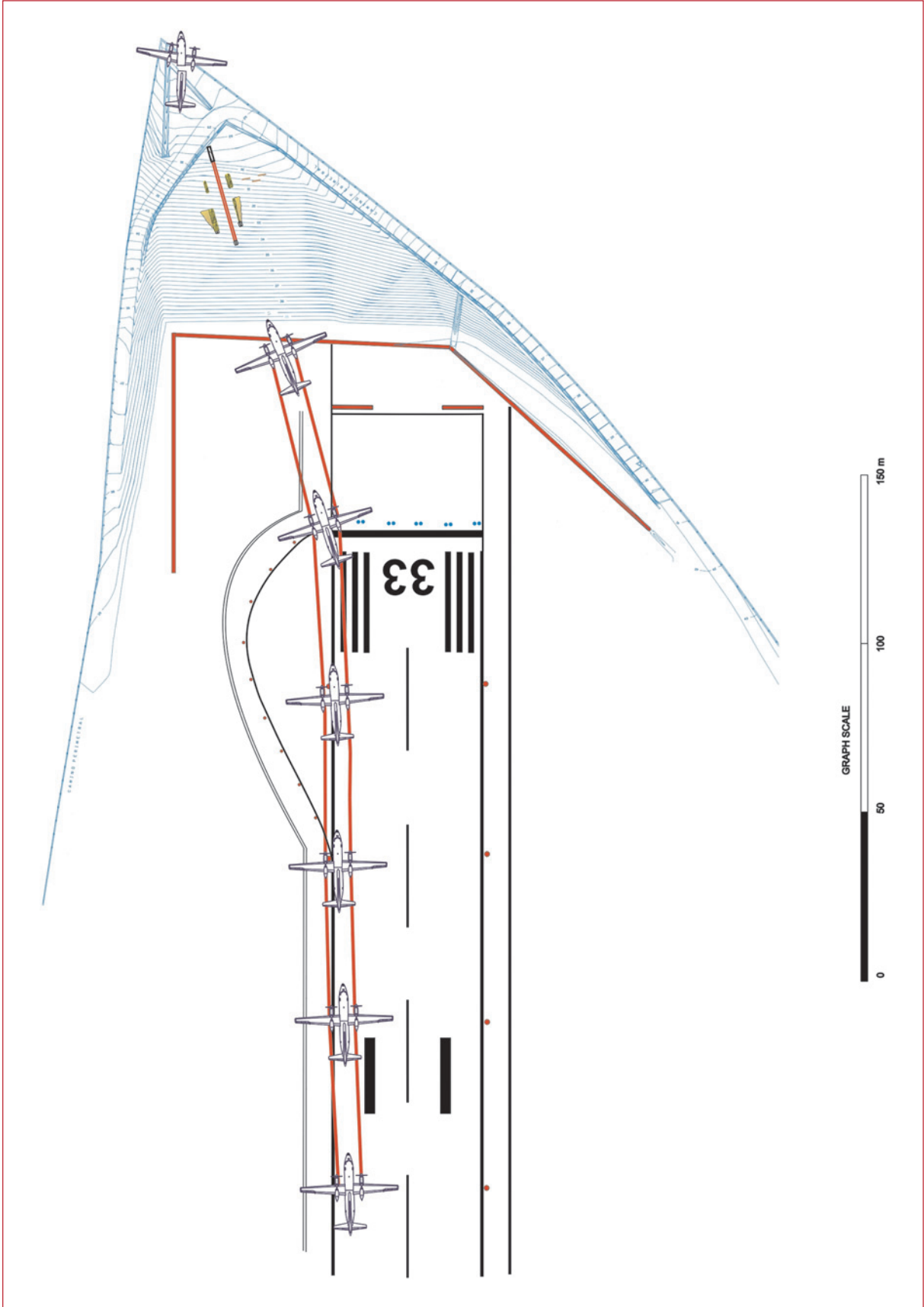

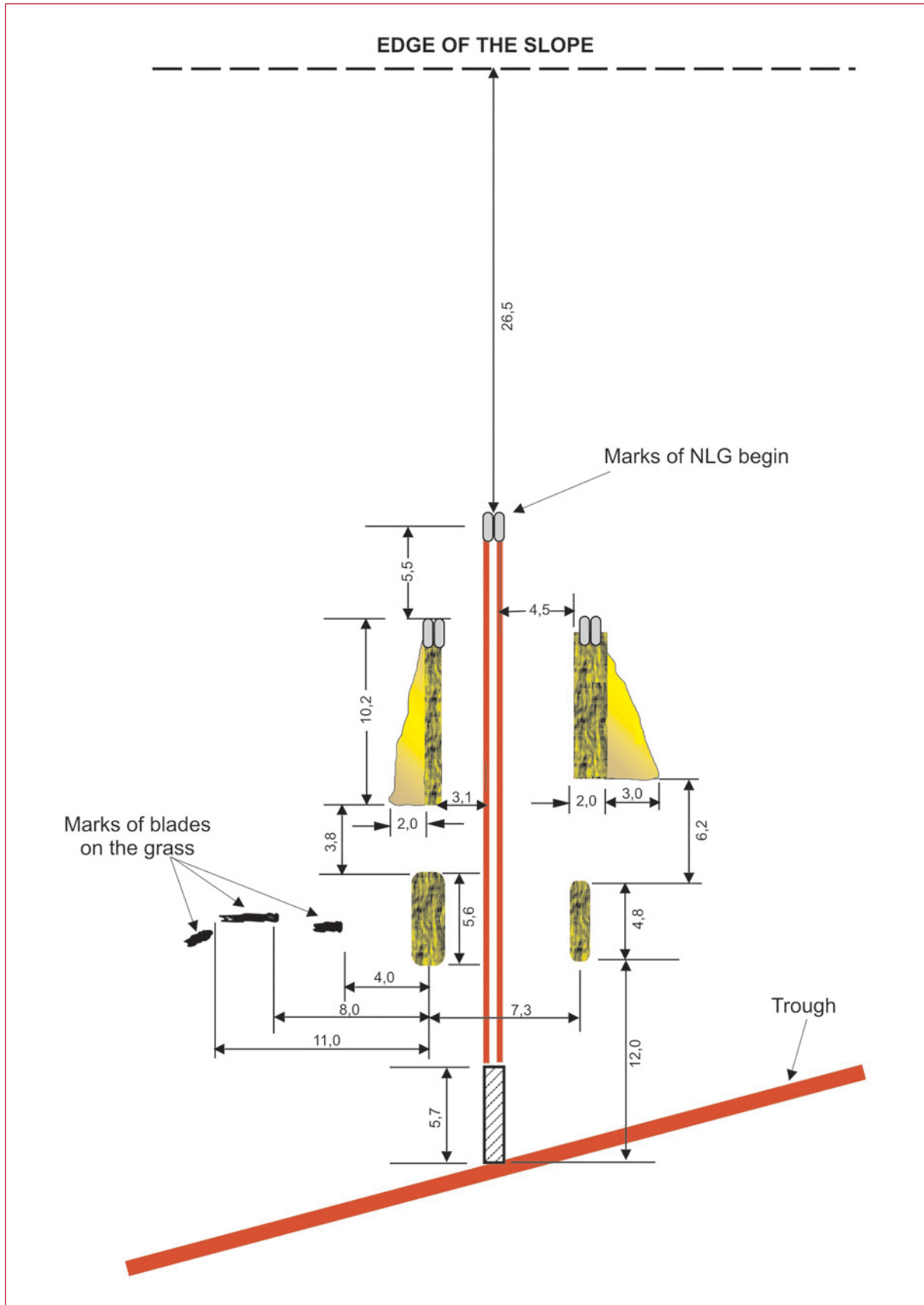

APPENDIX C

Photos of the ground track

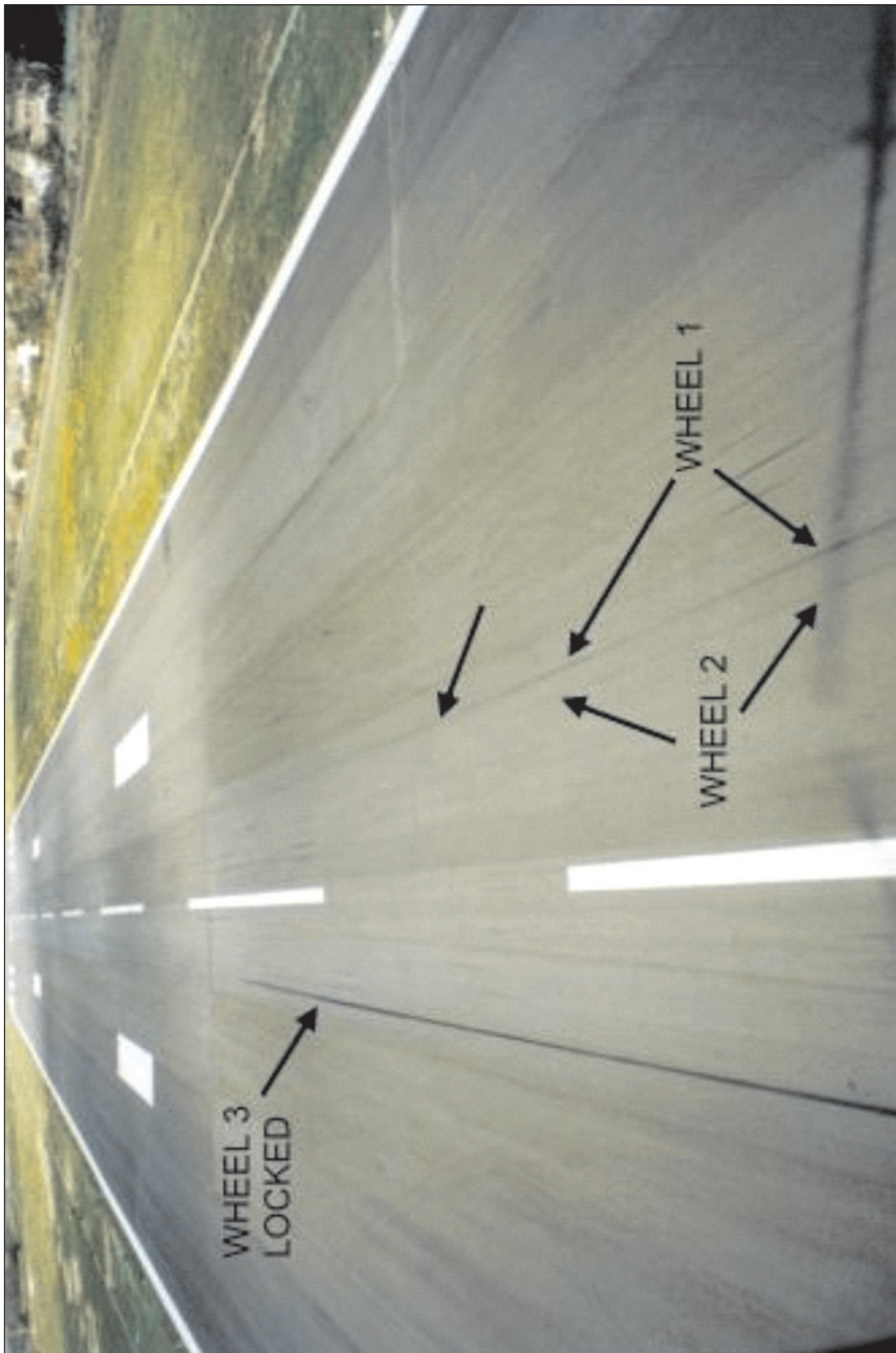

Photo 1. View towards runway 15 threshold (i.e., in the sense contrary to the landing roll). Track of wheel 3 clearly marked and showing signs of tire lock



Photo 2. *View in the sense of the landing roll. Track of wheel 3 crosses the runway axis*

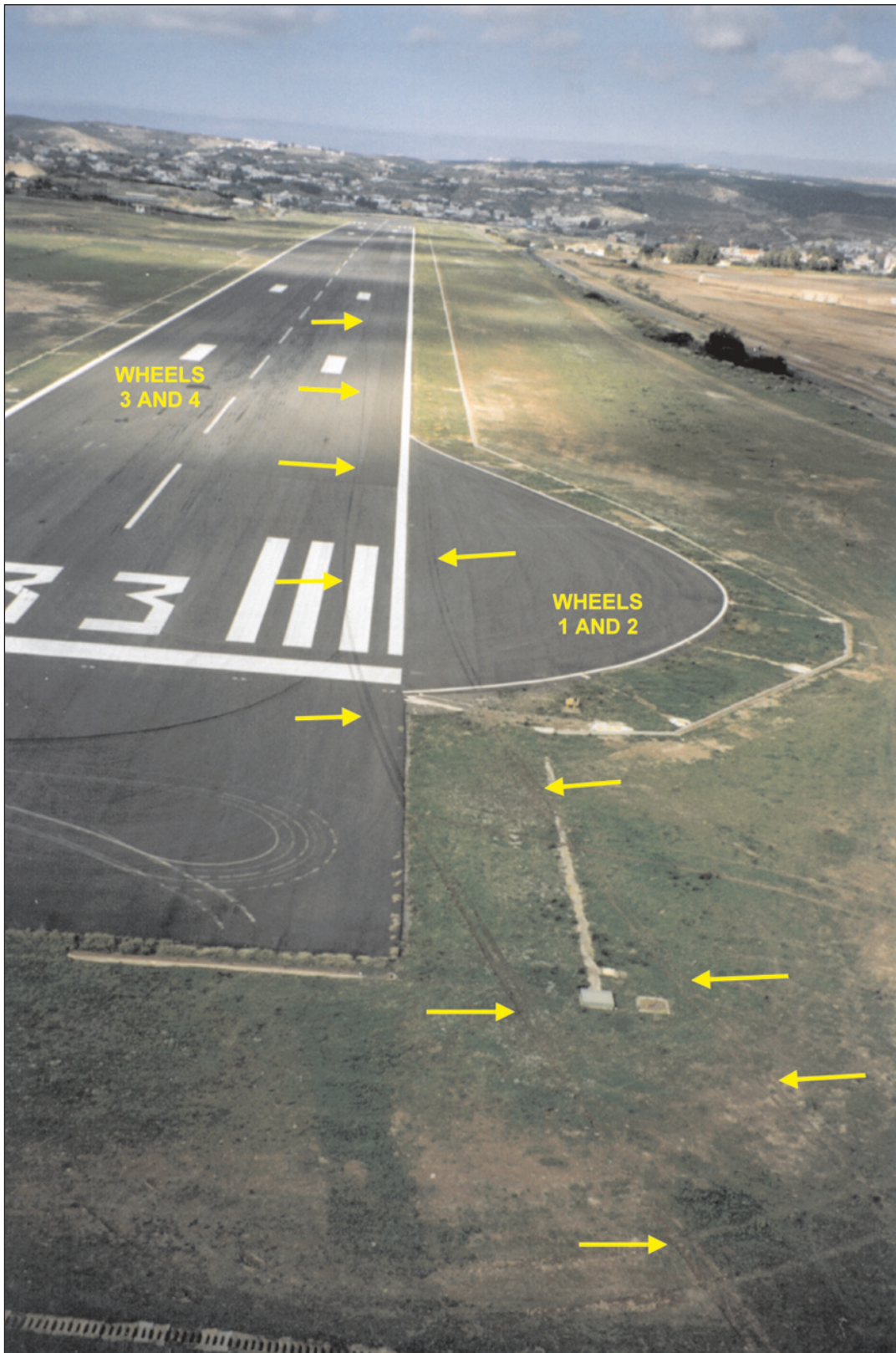

Photo 3. View in the sense contrary to the landing roll. Tracks of wheels 1 and 2 outside the runway

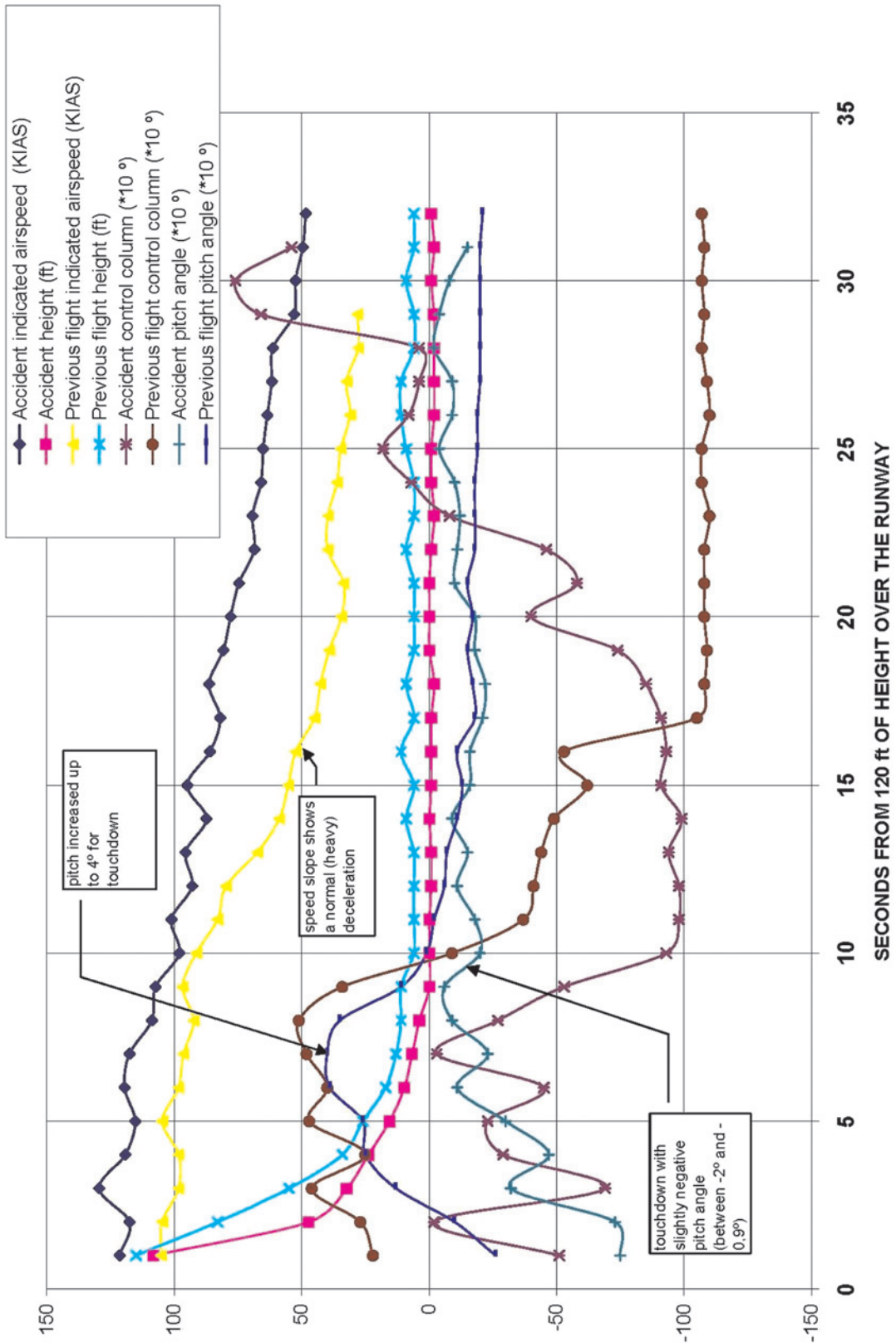

Photo 4. Final position of the aircraft and marks on the terrain of the embankment

APPENDIX D

DFDR graphs

COMPARISON ACCIDENT FLIGHT WITH PREVIOUS FLIGHT TO RUNWAY 15 OF MELILLA



Vertical acceleration during touchdown and landing roll
(the last 5 tenths of a second corresponding to the fall through
the downslope are included in a separate graph)

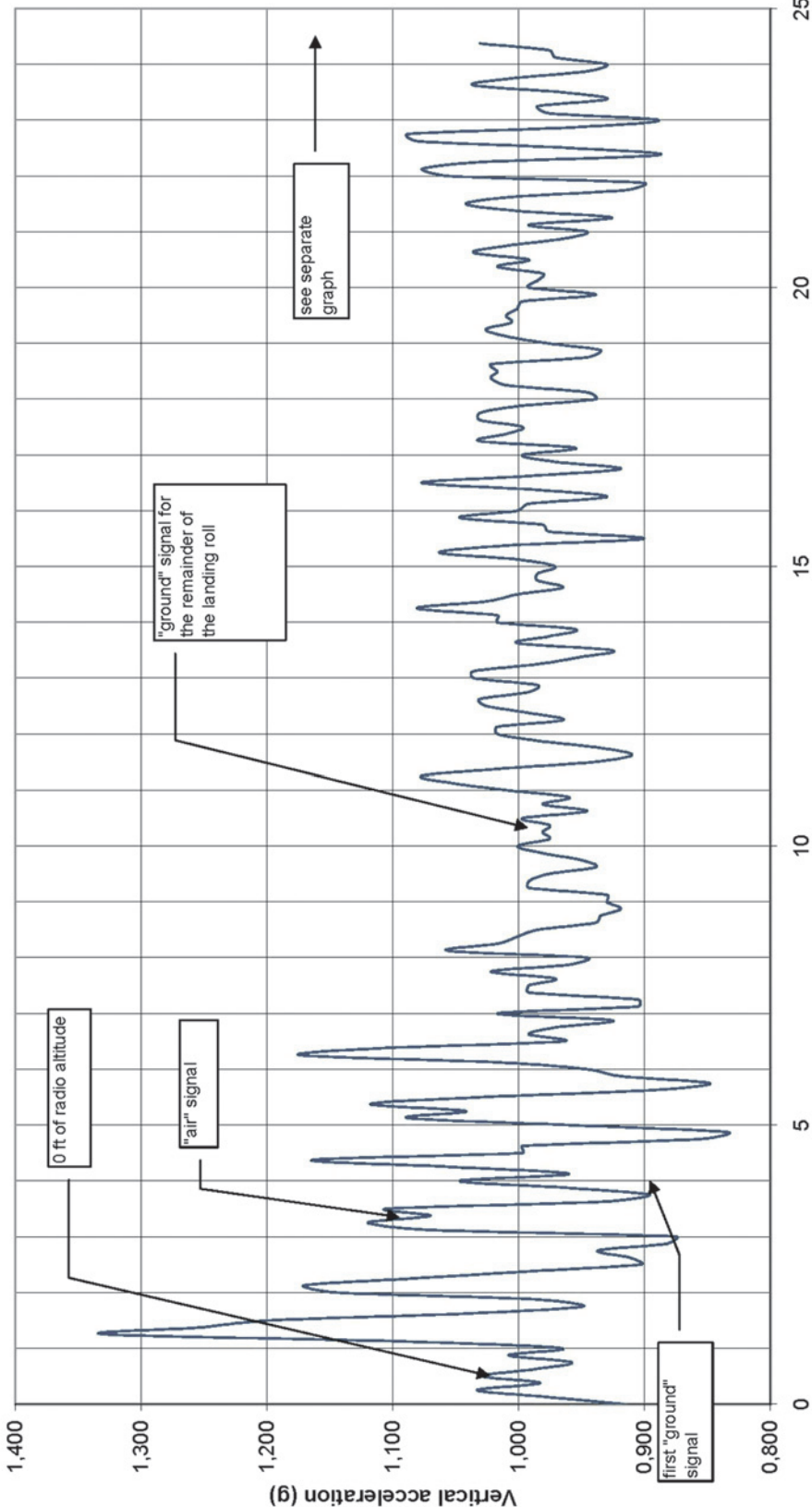

Seconds elapsed since 11:00:35 h, when the aircraft was 3.8 ft above the runway

Vertical acceleration in the downslope

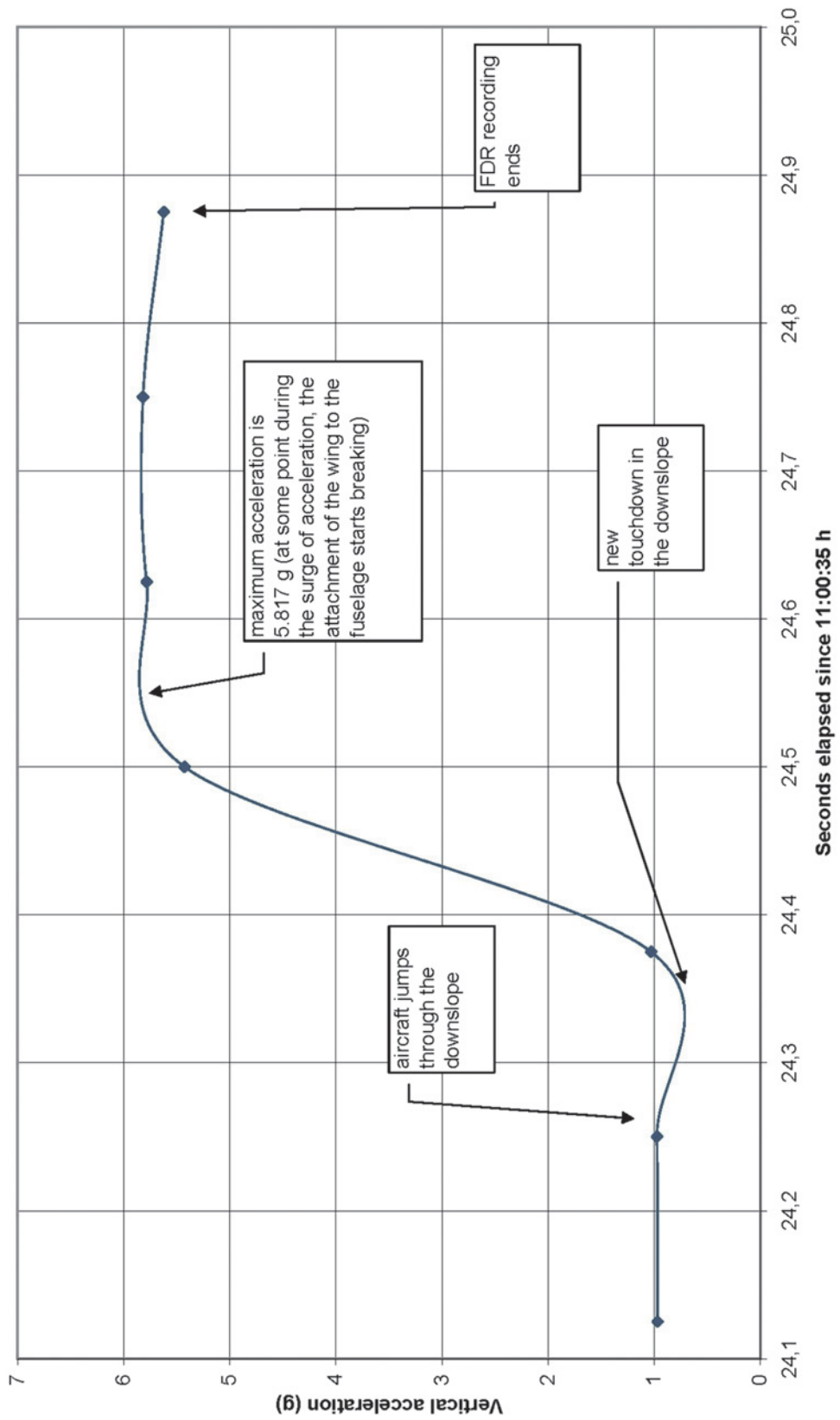

Comparison of vertical acceleration during 5 seconds around the touchdown moments in the accident flight and in the previous flight to runway 15 of Melilla

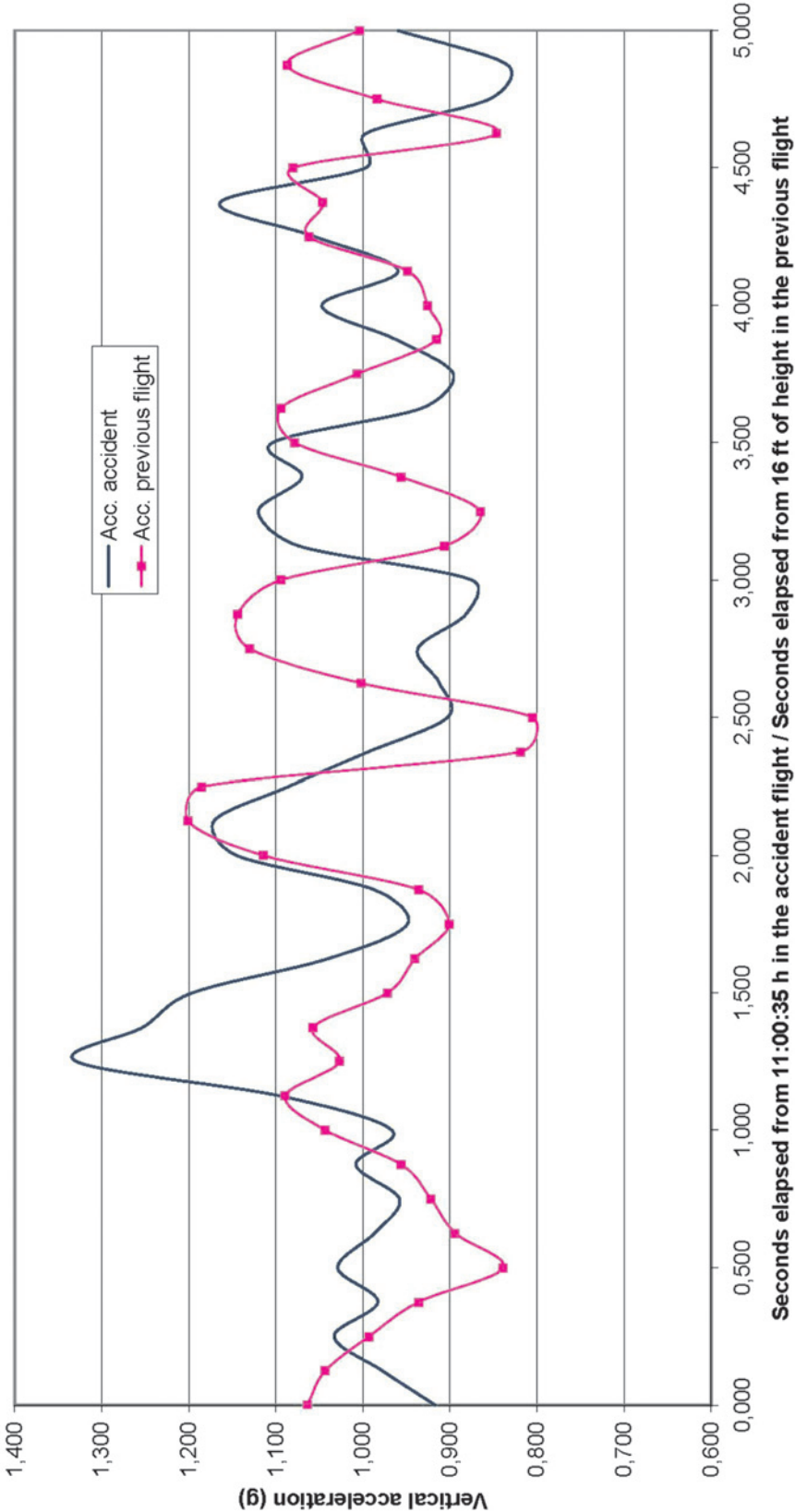

Comparison of deceleration between the accident flight and the previous flight to runway 15 of Melilla

